

**COUNTY OF SAN MATEO
PLANNING AND BUILDING DEPARTMENT**

DATE: February 11, 2015

TO: Planning Commission

FROM: Planning Staff

SUBJECT: EXECUTIVE SUMMARY: Consideration of the certification of an Initial Study/Mitigated Negative Declaration, a Non-Conforming Use Permit, Coastal Development Permit, and Design Review Permit, to allow construction of a 3,973 sq. ft. 2-story addition that includes a 660 sq. ft. attached 2-car garage, to an existing 1,888 sq. ft. 2-story single-family residence, on an existing 10,500 sq. ft. legal parcel, including removal of two (2) significant trees, located at 115 West Point Avenue in the unincorporated County area of Princeton. The Non-Conforming Use Permit is required to allow enlargement of a non-conforming residential use in a non-residential (Waterfront) zoning district. The project is appealable to the California Coastal Commission.

County File Number: PLN 2014-00133 (McGriff)

PROPOSAL

The applicant, Benjamin McGriff of McGriff Architects, requests permits to construct a 3,973 sq. ft. 2-story addition to an existing 1,888 sq. ft. 2-story single-family residence. The existing residential use, established prior to 1944, is non-conforming as residential uses are not a permitted use in the Waterfront (W) District. One 48" diameter-at-breast-height (dbh) Monterey cypress tree and one 24" dbh palm tree are proposed for removal.

RECOMMENDATION

That the Planning Commission certify the Initial Study/Mitigated Negative Declaration and approve the Non-Conforming Use Permit, Coastal Development Permit, and Design Review Permit, County File Number PLN 2014-00133, based on and subject to the required findings and conditions of approval listed in Attachment A.

SUMMARY

The site is relatively flat in topography and is located in a general industrial area predominantly characterized by warehouses and other similar uses, most of which support the local established small harbor business economy. One other single-family

residence is located on West Point Avenue north of the subject site. Pillar Point Harbor, Pillar Point Marsh and the shoreline beach area are within the immediate area of the site. The subject parcel is also located near the southern end of West Point Avenue immediately adjacent to a designated beach access point.

The project conforms with applicable policies of the County's General Plan and the San Mateo County Local Coastal Program (LCP). Specifically, the project complies with applicable Visual Quality policies of the General Plan, as the height of the proposed residence is kept at 22 ft. - 11 in., which is below the maximum allowed of 28 feet. The Coastside Design Review Committee (CDRC) considered the project at the July 10, 2014 meeting and determined that the project, as designed, complies with applicable Design Review Standards to warrant a recommendation for project approval. The addition to the existing single-family residence integrates with the existing neighborhood comprising predominantly of 2-story structures. The design of the single-family residence exhibits adequate façade articulation and the corresponding break-up of the roof mass helps to mitigate the appearance of mass and bulk and minimizes impacts to existing views from neighbors' properties.

Regarding the Half Moon Bay Airport Land Use Compatibility Plan (HAF ALUCP), staff has determined that the project's site location complies with the safety, noise and height limit criteria for compatibility. The project site is located in Runway Safety Zone 7, the Airport Influence Area (AIA), where the airport accident risk level is considered low. The project site is outside of the defined aircraft noise exposure contours and, therefore, would not be exposed to high levels of aircraft noise. The proposed height of 22 ft. - 11 in. would not penetrate the established airspace threshold.

Also, regarding the LCP, the project complies with policies regarding hazards, sensitive habitats and shoreline access, and is in compliance with design review standards and findings. Specifically, Shoreline Access Component policies require provision of shoreline access for any public or private development between the sea and the nearest road. Existing vertical access to the shoreline area westward is provided by West Point Avenue. The property owner owns four parcels located to the south of the subject parcel. Lateral beach access is provided along the beach south of these parcels. Existing vertical and lateral access would not be obstructed by the proposed development.

Regarding the requested Non-Conforming Use Permit, staff has determined that the project complies with the finding required by Section 6503 of the San Mateo County Zoning Regulations, that the establishment, maintenance and/or conducting of the use will not, under the circumstances of the particular case, be detrimental to the public welfare or injurious to property or improvements in said neighborhood. The project complies with the R-1/S-17 Zoning District development standards and design review standards. The project involves the expansion of an existing non-conforming residential use within the Waterfront (W) District, which consists predominantly of marine-related and industrial uses. The project would maintain residential setbacks, where no

setbacks are required for non-residential uses, such that the expanded use would not impact surrounding development.

Due to potential impacts associated with the project based on the expansion of the existing single-family residential use that adds more than 50% of the existing floor area to the existing structure, an Initial Study/Mitigated Negative Declaration (IS/MND) has been prepared for the project, pursuant to the California Environmental Quality Act (CEQA). In order to reduce geological hazard impacts to a less than significant level, one mitigation measure has been included as Condition No. 14 of Attachment A, requiring the completion of a design-level geotechnical investigation, including subsurface exploration to address the geotechnical conditions at the site, and to provide earthwork guidelines and foundation design criteria for the proposed remodeling and addition to the residence. All other project impacts were found to be less than significant. Therefore, as proposed and mitigated, the project would not result in any significant impacts to the environment.

DPA:fc – DPAZ0121_WFU.DOCX

**COUNTY OF SAN MATEO
PLANNING AND BUILDING DEPARTMENT**

DATE: February 11, 2015

TO: Planning Commission

FROM: Planning Staff

SUBJECT: Consideration of the certification of an Initial Study/Mitigated Negative Declaration, pursuant to the California Environmental Quality Act (CEQA), a Non-Conforming Use Permit, Coastal Development Permit, and Design Review Permit, pursuant to Sections 6134.6, 6328.4 and 6565.3 of the San Mateo County Zoning Regulations, respectively, to allow construction of a 3,973 sq. ft. 2-story addition that includes a 660 sq. ft. attached 2-car garage, to an existing 1,888 sq. ft. 2-story single-family residence, on an existing 10,500 sq. ft. legal parcel, including removal of two (2) significant trees, located at 115 West Point Avenue in the unincorporated County area of Princeton. The Non-Conforming Use Permit is required to allow enlargement of a non-conforming residential use in a non-residential (Waterfront) zoning district. The project is appealable to the California Coastal Commission.

County File Number: PLN 2014-00133 (McGriff)

PROPOSAL

The applicant, Benjamin McGriff of McGriff Architects, requests permits to construct a 3,973 sq. ft. 2-story addition to an existing 1,888 sq. ft. 2-story single-family residence. The existing residential use, established prior to 1944, is non-conforming to the zoning district as residential uses are not a permitted use in the Waterfront (W) District. The enlarged first floor consists of the living room, kitchen, dining room, sun room and a new rear deck. The old deck is replaced by a new outdoor deck that wraps around the rear and left side areas of the residence. As proposed, the new garage and second floor study area above would be connected by a central wing consisting of a covered entryway, laundry area and shower room. A new driveway provides direct access from West Point Avenue to the proposed 2-car garage. The existing second floor, consisting of one bedroom, would be enlarged to include two bedrooms sharing a central common bathroom and a master bedroom and bath. One 48" diameter-at-breast-height (dbh) Monterey cypress tree and one 24" dbh palm tree are proposed for removal.

RECOMMENDATION

That the Planning Commission certify the Initial Study/Mitigated Negative Declaration and approve the Non-Conforming Use Permit, Coastal Development Permit, and Design

Review Permit, County File Number PLN 2014-00133, based on and subject to the required findings and conditions of approval listed in Attachment A.

BACKGROUND

Report Prepared By: Dennis P. Aguirre, Project Planner, Telephone 650/363-1867

Applicant/Owner: Benjamin McGriff (McGriff Architects)/Reza Malek

Location: 115 West Point Avenue, Princeton

APNs: 047-032-160, and -170

Parcel Size: 10,500 sq. ft.

Parcel Legality: Certificate of Compliance (Type A), recorded on December 4, 2014

Existing Zoning: W/DR/CD (Waterfront District/Design Review/Coastal Development)

General Plan Designation: General Industrial

Existing Land Use: Residential

Sphere-of-Influence: City of Half Moon Bay

Existing Land Use: Single-Family Residential

Water Supply: Coastside County Water District

Sewage Disposal: Granada Community Services District

Flood Zone: Zone X, areas of minimal flooding, Community Panel No. 06081 C0138E, effective October 16, 2012

Environmental Evaluation: Mitigated Negative Declaration published with a public review period starting on January 21, 2015 and ending on February 9, 2015.

Setting: The site is relatively flat in topography and is located in a general industrial area predominantly characterized by warehouses and similar other uses, most of which support the local established small harbor business economy. One other single-family residence is located on this street north of the subject site. The site is accessed via West Point Avenue. Pillar Point Harbor, Pillar Point Marsh and the shoreline beach area are within the immediate area of the site. The subject parcel is located near the southern end of West Point Avenue immediately adjacent to a designated beach access point.

Chronology:

<u>Date</u>	<u>Action</u>
April 23, 2014	- Application submitted.
July 10, 2014	- Coastside Design Review Committee (CDRC) recommends approval of the project.
September 12, 2014	- Submittal of a Geotechnical Report prepared by Romig Engineers.
December 4, 2014	- Certificate of Compliance (Type A) recorded and Notice of Merger filed.
December 12, 2014	- Submittal of a Tsunami Runup and Force Analysis Report prepared by GeoSoils, Inc.
January 21, 2015	- Initial Study/Mitigated Negative Declaration published with public review period ending on February 9, 2015.
February 11, 2015	- Planning Commission public hearing.

DISCUSSION

A. KEY ISSUES

1. Conformance with the County General Plan

Upon review of the provisions of the General Plan, staff has determined that the project complies with all applicable General Plan policies, including the following:

Visual Quality Policy 4.14(a) (*Appearance of New Development*) specifically addresses the requirement to regulate development to promote and enhance good design, site relationships and other aesthetic considerations. The addition is in keeping with the established design streetscape, which includes predominantly industrial structures and one other single-family residence. The architectural elements and exterior materials and colors proposed are complementary with the neighborhood design context. Potential mass and bulk impacts have been mitigated through the proposed facade articulation and the break-up of the roof mass through the addition of dormers. The height of the structure is kept at 22 ft. - 11 in., which is below the maximum allowed of 28 feet. The project has received a recommendation for approval from the Coastside Design Review Committee (CDRC) based on the CDRC's conclusion that the project conforms to the

design standards that implement this policy as discussed in Section 5 below.

Visual Quality Policy 4.35 (*Urban Area Design Concepts*) calls for new development to maintain and, where possible, improve upon the appearance and visual character of development in urban areas, and to ensure that new development in urban areas is designed and constructed to contribute to the orderly and harmonious development of the locality. The structure is well articulated with exterior walls that are broken up with well-placed windows and dormers. The proposed colors are earth tones that complement other neighborhood structures. The materials used, such as cedar shingles and galvanized aluminum standing seam roof, are similar with materials used in the construction of the other single-family residence in the neighborhood located at 179 West Point Avenue, and other industrial structures in the neighborhood. The covered garage accommodates off-street parking for two cars. The structure's height of 22 ft. -11 in., well-articulated exterior facades, and the use of earth-tone colors for the project color scheme contribute to the project's compatibility with the neighborhood character.

Urban Land Use Policy 8.24 (*Land Use Compatibility*) calls for the County to ensure that industrial development is compatible with adjacent land uses. The project involves the expansion of an existing non-conforming residential use within the Waterfront (W) District, which consists predominantly of marine-related and industrial uses. The project would maintain residential setbacks, where no setbacks are required for non-residential uses, such that the expanded use would not impact surrounding development.

Water Supply Policy 10.10 (*Water Suppliers in Urban Areas*) requires consideration of water systems as the preferred method of water supply in urban areas. The Coastside County Water District, as the service provider for this urban area, has confirmed that a 5/8th-inch (20 gallons per minute) non-priority water service connection from the Crystal Springs Water Supply Project was installed in 1993 for this site.

Wastewater Policy 11.5 (*Wastewater Management in Urban Areas*) requires consideration of sewerage systems as the appropriate method of wastewater management in urban areas. The Granada Community Services District (GCSD), as the service provider for this urban area, has provided a written statement that projects involving additions to existing structures do not require an application for a sewer connection permit to connect to GCSD's wastewater facilities.

2. Conformance with the Local Coastal Program

Staff has determined that the project, as conditioned, is in compliance with applicable Local Coastal Program (LCP) policies, including the relevant components elaborated as follows:

a. Locating and Planning New Development Component

Policy 1.17 (*Existing Developed Areas*) calls for conserving, improving, and revitalizing residential, commercial and industrial areas. The project complies with this policy since the addition to the existing residence maintains its design integrity while at the same time enhancing the visual character of the surrounding industrial area. The proposed expansion of the non-conforming use would not negatively impact surrounding development.

b. Sensitive Habitats Component

Policy 7.3 (*Protection of Sensitive Habitats*) prohibits any land use or development which would have significant adverse impact on sensitive habitat areas and requires development in areas adjacent to sensitive habitats to be sited and designed to prevent impacts that could significantly degrade the sensitive habitats. The area of the proposed addition is disturbed and located within the building envelope of the site. A Preliminary Delineation of Wetlands Report prepared by Coast Range Biological, LLC (Wetlands Report; included in Attachment E), dated December 2013, showed the location of a wetland area, the Pillar Point Marsh, to be 125 feet southwest of the project site. The project site falls outside the minimum 100-foot buffer zone required by the County Local Coastal Program.

c. Visual Resources Component

Policy 8.9(g) (*Trees*) allows the removal of trees which pose a threat to public health, safety and welfare. The proposed removal of two significant trees is not in conflict with the County's Significant Tree Regulations. As described in the Tree Assessment Report (Arborist Report) from Jim Gillespie, Consultant Arborist, one 24" dbh palm tree is required to be removed since it is located within the building envelope of the proposed addition. The removal of a 48" dbh Monterey cypress tree is recommended to allow more light and moisture to sustain the health of an existing Monterey cypress tree that is to remain. The proposed landscaping shown on Sheet A-1.01, included in Attachment E, includes the plantings of four (4) new 15-gallon trees. The Coastside Design Review Officer has determined that the proposed replacement meets the requirement of Section

6565.21 of the Zoning Regulations to replace each significant indigenous tree to be removed with three (3) or more trees of the same species using at least five (5) gallon size stock.

Policy 8.12(a) (*General Regulations*) requires that the Design Review Zoning District be applied to areas of the Coastal Zone. Section 6565.7 of the Zoning Regulations requires CDRC review of residential and mixed-use projects in the Midcoast LCP Update Project Area. For further discussion of the CDRC's review of the project and the project compliance with Design Review Standards, see Section 5.

d. Hazards Component

Policy 9.3 (*Regulation of Geologic Hazard Areas*) requires the application of the Resource Management (RM) Zoning Ordinance, specifically Sections 6326.3 (*Seismic Fault/Fracture Area Criteria*) and 6326.3 (*Tsunami Inundation Area Criteria*) to the site which is located in a designated geologic hazard area.

A Geotechnical Report prepared by Romig Engineers, Inc. (Geotechnical Report; included in Attachment E), dated September 12, 2014, located the primary trace of the San Gregorio/Seal Cove Fault to be west of the project site. The report declares that there is no evidence to support the occurrence of potential ground surface rupture at the site relative to the fault traces. Although no fault trenching is required as a means to confirm this evaluation, the Geotechnical Report recommends the following mitigation measure (included as Condition No. 14 in Attachment A):

Mitigation Measure 1: Complete a design-level geotechnical investigation including subsurface exploration to address the geotechnical conditions at the site and to provide earthwork guidelines and foundation design criteria for the proposed remodeling and addition to the residence.

The Geotechnical Section completed a preliminary review of this report and found it adequate for Planning approval. A detailed review will be conducted upon submittal of a building permit application, as specified in Condition No. 37.

The project site is located in a tsunami hazard zone, as identified in the San Mateo County General Plan Hazards Map. A Tsunami Runup and Force Analysis Report (Tsunami Report; included in Attachment E) prepared by GeoSoils, Inc., dated December 12, 2014, was submitted that indicated the project site to be safe from potential

hazards due to the presence of the breakwater that dissipates wave forces caused by tsunamis.

e. Shoreline Access Component

Policy 10.1 (*Permit Conditions for Shoreline Access*) requires some shoreline access provision as a condition of granting development permits for any public or private development between the sea and the nearest road. The policy requires the type of provision, the location of the access and the amount and type of improvements to be consistent with the policies of the Shoreline Access Component. The subject site is located between the Pacific Ocean southward and West Point Avenue northward and is therefore subject to this policy.

Policy 10.18 (*Lateral Access (Shoreline Destinations) Without Coastal Bluffs*) requires the provision of access to and along the beach during normal tides, with a right-of-way at least 25 feet in width, between the mean high tide line and the first line of terrestrial vegetation. Vertical access to the beach is provided by West Point Avenue. The property owner, who owns four parcels located to the south of the subject parcel, provides lateral beach access through these properties. Existing vertical and lateral access would not be obstructed by the proposed development.

Policy 10.27 (*Residential*) requires separation between shoreline access and adjacent residential uses to protect the privacy and security of houses and the public nature and use of the shoreline. Specifically, the policy requires development to keep the edge of the lateral shoreline access trails 25 feet and vertical shoreline access trails 10 feet from any occupied residential structure. The project site is separated from West Point Avenue (vertical access) by an existing 11 ft. - 4 1/2 in. front setback and from the edge of lateral shoreline access by over 50 feet.

3. Conformance with the Half Moon Bay Airport (HAF) Airport Land Use Compatibility Plan (ALUCP)

Upon review of the provisions of the Half Moon Bay Airport (HAF) Airport Land Use Compatibility Plan (ALUCP) for the environs of Half Moon Bay Airport, as adopted by the City/County Association of Governments (C/CAG) in October 9, 2014, staff has determined that the project's site location complies with the safety, noise and height limit criteria for compatibility. The project site is located in Runway Safety Zone 7, the Airport Influence Area (AIA), where the airport accident risk level is considered low. The project site is outside of the defined aircraft noise exposure contours and, therefore,

would not be exposed to high levels of aircraft noise. The proposed height of 22 ft. - 11 in. would not penetrate the established airspace threshold.

4. Conformance with Zoning Regulations

Pursuant to Section 6134.6, the enlargement of a non-conforming residential use is subject to the issuance of a use permit, provided that the project complies with the R-1/S-17 Zoning District development standards.

Development Standards

The following table summarizes the project’s compliance with the development standards of the R-1/S-17 Zoning District:

Development Regulations	Required	Proposed
Building Site Area	5,000 sq. ft.	10,500 sq. ft.
Building Site Width	50 ft.	105 ft.
Lot Coverage	35% max. (3,675 sq. ft.)	23% (2,418 sq. ft.)
Floor Area	53% max. (5,564 sq. ft.)	38% (3,973 sq. ft.)
Maximum Height of Structure	28 ft.	22 ft. - 11 in.
Minimum Front Yard Setback	20 ft.	11 ft. - 4 1/2 in. (existing)* 48 ft. - 7 in. (new garage)
Minimum Right Side Setback	5 ft.	5 ft. - 1 in.
Minimum Left Side Setback	5 ft.	30 ft.
Minimum Rear Yard Setback	20 ft.	21 ft. - 6 1/2 in.
Parking	Two covered spaces	Two covered spaces
*Legal non-conforming.		

5. Conformance with Design Review District Guidelines

The Coastside Design Review Committee (CDRC) considered the project at a regularly scheduled CDRC meeting on July 10, 2014, and adopted the findings to recommend project approval, pursuant to the Design Review Standards for One-Family Residential Development in the Midcoast, Section 6565.20 of the San Mateo County Zoning Regulations, specifically elaborated as follows:

- a. The proposed structure exhibits numerous articulated areas that include the connection of two structures with an enclosed entry hall, and architectural features such as gables and dormers (Section 6565.20(D)1.d and e).

- b. The proposed architectural style incorporates design elements such as gable roofs, dormers and well placed fenestration with trim. As proposed, the residence establishes itself as an example for future neighborhood renovations (Section 6565.20(D)2).
- c. The primary gable roof form serves both as a mitigating element for potential mass and bulk impacts and maintains consistency with the existing residence's roof form (Section 6565.20(D)3).
- d. As proposed and conditioned, the materials such as western red cedar shingles and earth-tone colors as the project's color scheme enhance the neighborhood and are compatible with coastal architecture in the area. Condition No. 4.a includes a recommendation to explore changing the exterior material at the entry corner hall to a translucent material, if deemed feasible (Section 6565.20(D)4).

6. Conformance with Use Permit Findings

Pursuant to Section 6134.6, the enlargement of a non-conforming residential use is subject to the approval of a use permit, provided that the project complies with the R-1/S-17 development standards. The project complies with these standards as discussed in Section 4 of this report.

Pursuant to Section 6503 of the San Mateo County Zoning Regulations, staff has determined that the establishment, maintenance and/or conducting of the use will not, under the circumstances of the particular case, be detrimental to the public welfare or injurious to property or improvements in said neighborhood, based on project compliance with the R-1/S-17 development standards and design review standards. As proposed and mitigated, the project would not result in any significant adverse environmental impacts on coastal resources as determined by the Initial Study/Mitigated Negative Declaration.

B. ENVIRONMENTAL REVIEW

Due to potential impacts associated with the project based on the expansion of the existing single-family residential use that adds more than 50% of the existing floor area to the existing structure, an Initial Study/Mitigated Negative Declaration (IS/MND) has been prepared for the project, pursuant to the California Environmental Quality Act (CEQA). The IS/MND (Attachment E) was published on January 21, 2015, with a review period ending on February 9, 2015. As of the writing of this report, no comments have been received. Any comments received will be addressed at the public hearing. In order to reduce geological hazard impacts to a less than significant level, one mitigation measure has been included as Condition No. 14 of Attachment A, requiring the completion of a design-level geotechnical investigation, including subsurface exploration to address the

geotechnical conditions at the site, and to provide earthwork guidelines and foundation design criteria for the proposed remodeling and addition to the residence.

It should be noted that the IS/MND incorrectly stated that the two trees proposed for removal were both Monterey cypress trees. As described in this report, the two trees proposed for removal consist of one 24" dbh palm tree and one 48" dbh Monterey cypress tree.

C. REVIEW BY THE MIDCOAST COMMUNITY COUNCIL

The Midcoast Community Council (MCC) did not forward a response to staff's referral for this project. The MCC has been notified of the Planning Commission's review of this project.

D. REVIEW BY THE CALIFORNIA COASTAL COMMISSION

The California Coastal Commission (CCC) did not forward a response to staff's referral for this project. The CCC has been notified of the Planning Commission's review of this project.

E. OTHER REVIEWING AGENCIES

Building Inspection Section
Department of Public Works
Environmental Health Division
Coastside Fire Protection District
Coastside County Water District
Granada Community Services District

ATTACHMENTS

- A. Recommended Findings and Conditions of Approval
- B. Vicinity Map
- C. Project Plans
- D. CDRC Decision Letter, dated November 24, 2014
- E. Initial Study/Mitigated Negative Declaration and Attachments
- F. Site Photos

DPA:fc – DPAZ0122_WFU.DOCX

County of San Mateo
Planning and Building Department

RECOMMENDED FINDINGS AND CONDITIONS OF APPROVAL

Permit or Project File Number: PLN 2014-00133 Hearing Date: February 11, 2015

Prepared By: Dennis P. Aguirre
Project Planner

For Adoption By: Planning Commission

RECOMMENDED FINDINGS

Regarding the Environmental Review, Find:

1. That the Initial Study/Mitigated Negative Declaration is complete, correct and adequate, and prepared in accordance with the California Environmental Quality Act and applicable State and County Guidelines.
2. That, on the basis of the Initial Study/Mitigated Negative Declaration and comments hereto, there is no evidence that the project, subject to the mitigation measures contained in the Mitigated Negative Declaration, will have a significant effect on the environment.
3. That the Initial Study/Mitigated Negative Declaration reflects the independent judgment of San Mateo County.
4. That the mitigation measures identified in the Mitigated Negative Declaration, agreed to by the applicant, placed as conditions on the project, and identified as part of this public hearing, have been incorporated into the Mitigation and Reporting Plan in conformance with California Public Resources Code Section 21081.6.

Regarding the Coastal Development Permit, Find:

5. That the project, as described in the application and accompanying materials required by the Zoning Regulations, Section 6328.4, and as conditioned in accordance with Section 6328.14, conforms with the applicable policies and required findings of the San Mateo County Local Coastal Program (LCP). Specifically, the project complies with policies regarding hazards, sensitive habitats and shoreline access and is in compliance with design review standards and findings, as described further in the staff report dated February 11, 2015.

Regarding the Design Review, Find:

6. That, with the conditions of approval recommended by the Coastside Design Review Committee at its meeting of July 10, 2014, the project is in compliance with the Design Review Standards for the Coastside. The project, as designed and conditioned, complements the predominant style of the neighborhood homes. The project's expansion of the existing residence adequately protects neighbors' privacy and views; is well articulated; uses colors and materials that appear natural; and uses downward-directed exterior lighting fixtures.

Regarding the Use Permit, Find:

7. Pursuant to Section 6503 of the San Mateo County Zoning Regulations, that the establishment, maintenance and/or conducting of the use will not, under the circumstances of the particular case, be detrimental to the public welfare or injurious to property or improvements in said neighborhood based on the compliance with the R-1/S-17 Zoning District development standards and design review standards. As proposed and mitigated, the project would not result in any significant adverse environmental impacts on coastal resources as determined by the Initial Study/Mitigated Negative Declaration.

RECOMMENDED CONDITIONS OF APPROVAL

Current Planning Section

1. The project shall be constructed in compliance with the plans approved by the Planning Commission on February 11, 2015. Any changes or revisions to the approved plans shall be submitted to the Design Review Officer for review and approval prior to implementation. Minor adjustments to the project may be approved by the Design Review Officer if they are consistent with the intent of and are in substantial conformance with this approval. Alternatively, the Design Review Officer may refer consideration of the revisions to the Coastside Design Review Committee, with applicable fees to be paid.
2. The Use Permit, Coastal Development Permit and Design Review final approvals shall be valid for five (5) years from the date of approval, in which time a building permit shall be issued and a completed inspection (to the satisfaction of the Building Inspector) shall have occurred within 180 days of its issuance. The Use Permit, Coastal Development Permit and Design Review approval may be extended by one 1-year increment with submittal of an application for permit extension and payment of applicable extension fees sixty (60) days prior to the expiration date.
3. The applicant shall include the approval letter on the top pages of the building plans to ensure that the conditions of approval are included with the on-site plans.

4. The applicant shall submit the following items and/or indicate the following on plans submitted for a building permit, as stipulated by the Coastside Design Review Committee:
 - a. Exterior material at the entry corner hall to be of translucent material, if deemed feasible.

5. The applicant shall provide “finished floor elevation verification” to certify that the structure is actually constructed at the height shown on the submitted plans. The applicant shall have a licensed land surveyor or engineer establish a baseline elevation datum point in the vicinity of the construction site.
 - a. The applicant shall maintain the datum point so that it will not be disturbed by the proposed construction activities until final approval of the building permit.
 - b. This datum point and its elevation shall be shown on the submitted site plan. This datum point shall be used during construction to verify the elevation of the finished floors relative to the existing natural or to the grade of the site (finished grade).
 - c. Prior to Planning approval of the building permit application, the applicant shall also have the licensed land surveyor or engineer indicate on the construction plans: (1) the natural grade elevations at the significant corners (at least four) of the footprint of the proposed structure on the submitted site plan, and (2) the elevations of proposed finished grades.
 - d. In addition, (1) the natural grade elevations at the significant corners of the proposed structure, (2) the finished floor elevations, (3) the topmost elevation of the roof and (4) garage slab elevation must be shown on the plan, elevations, and cross-section (if one is provided).
 - e. Once the building is under construction, prior to the below floor framing inspection or the pouring of the concrete slab (as the case may be) for the lowest floor(s), the applicant shall provide to the Building Inspection Section a letter from the licensed land surveyor or engineer certifying that the lowest floor height--as constructed--is equal to the elevation specified for that floor in the approved plans. Similarly, certifications on the garage slab and the topmost elevation of the roof are required.
 - f. If the actual floor height, garage slab, or roof height--as constructed--is different than the elevation specified in the plans, then the applicant shall cease all construction and no additional inspections shall be approved until a revised set of plans is submitted to and subsequently approved by both the Building Official and Community Development Director.

6. During project construction, the applicant shall, pursuant to Chapter 4.100 of the San Mateo County Ordinance Code, minimize the transport and discharge of stormwater runoff from the construction site into storm drain systems and water bodies by:
 - a. Using filtration materials on storm drain covers to remove sediment from dewatering effluent.
 - b. Stabilizing all denuded areas and maintaining erosion control measures continuously between October 1 and April 30.
 - c. Removing spoils promptly, and avoiding stockpiling of fill materials, when rain is forecast. If rain threatens, stockpiled soils and other materials shall be covered with a tarp or other waterproof material.
 - d. Storing, handling, and disposing of construction materials and wastes so as to avoid their entry to the storm drain system or water body.
 - e. Avoiding cleaning, fueling or maintaining vehicles on-site, except in an area designated to contain and treat runoff.
 - f. Limiting and timing application of pesticides and fertilizers to avoid polluting runoff.
7. The applicant shall include an erosion and sediment control plan on the plans submitted for the building permit. This plan shall identify the type and location of erosion control devices to be installed upon the commencement of construction in order to maintain the stability of the site and prevent erosion and sedimentation off-site.
8. All new power and telephone utility lines from the street or nearest existing utility pole to the main dwelling and/or any other structure on the property shall be placed underground.
9. The applicant shall apply for a building permit and shall adhere to all requirements from the Building Inspection Section, the Department of Public Works and the Coastside Fire Protection District.
10. No site disturbance shall occur, including any grading or tree removal, until a building permit has been issued, and then only those trees approved for removal shall be removed.
11. To reduce the impact of construction activities on neighboring properties, comply with the following:

- a. All debris shall be contained on-site; a dumpster or trash bin shall be provided on-site during construction to prevent debris from blowing onto adjacent properties. The applicant shall monitor the site to ensure that trash is picked up and appropriately disposed of daily.
 - b. The applicant shall remove all construction equipment from the site upon completion of the use and/or need of each piece of equipment which shall include but not be limited to tractors, back hoes, cement mixers, etc.
 - c. The applicant shall ensure that no construction-related vehicles shall impede through traffic along the right-of-way on West Point Avenue. All construction vehicles shall be parked on-site outside the public right-of-way or in locations which do not impede safe access on West Point Avenue. There shall be no storage of construction vehicles in the public right-of-way.
12. The exterior color samples submitted to the Coastside Design Review Committee are approved. Color verification shall occur in the field after the applicant has applied the approved materials and colors but before a final inspection has been scheduled.
 13. Noise levels produced by the proposed construction activity shall not exceed the 80-dBA level at any one moment. Construction activities shall be limited to the hours from 7:00 a.m. to 6:00 p.m., Monday through Friday, and 9:00 a.m. to 5:00 p.m. on Saturday. Construction operations shall be prohibited on Sunday and any national holiday.
 14. **Mitigation Measure 1:** Complete a design-level geotechnical investigation including subsurface exploration to address the geotechnical conditions at the site and to provide earthwork guidelines and foundation design criteria for the proposed remodeling and addition to the residence.

Building Inspection Section

15. The applicant shall apply for a building permit.

Department of Public Works

16. Prior to the issuance of the building permit or planning permit (for Provision C.3 Regulated Projects), the applicant shall have prepared, by a registered civil engineer, a drainage analysis of the proposed project and submit it to the Department of Public Works for review and approval. The drainage analysis shall consist of a written narrative and a plan. The flow of the stormwater onto, over, and off of the property shall be detailed on the plan and shall include adjacent lands as appropriate to clearly depict the pattern of flow. The analysis shall detail the measures necessary to certify adequate drainage. Post-development flows and velocities shall not exceed those that existed in the pre-developed state.

Recommended measures shall be designed and included in the improvement plans and submitted to the Department of Public Works for review and approval.

17. Prior to the issuance of the building permit or planning permit (if applicable), the applicant shall submit a driveway "Plan and Profile," to the Department of Public Works, showing the driveway access to the parcel (garage slab) complying with County Standards for driveway slopes (not to exceed 20%) and to County Standards for driveways (at the property line) being the same elevation as the center of the access roadway. When appropriate, as determined by the Department of Public Works, this plan and profile shall be prepared from elevations and alignment shown on the roadway improvement plans. The driveway plan shall also include and show specific provisions and details for both the existing and the proposed drainage patterns and drainage facilities.
18. No proposed construction work within the County right-of-way shall begin until County requirements for the issuance of an encroachment permit, including review of the plans, have been met and an encroachment permit issued. Applicant shall contact a Department of Public Works Inspector 48 hours prior to commencing work in the right-of-way.
19. The applicant shall submit to the Project Planner a copy of the recorded Grant Deed(s) of only the parcels to be merged for review and approval prior to Planning Department approval.
20. Prior to the issuance of the building permit, the applicant will be required to provide payment of "roadway mitigation fees" based on the square footage (assessable space) of the proposed building per Ordinance No. 3277.
21. The applicant shall submit a permanent stormwater management plan in compliance with the County's Drainage Policy and National Pollution Discharge Elimination System (NPDES) requirements for review and approval by the Department of Public Works.

Coastside Fire Protection District

22. Smoke detectors which are hardwired: As per the California Building Code (CBC), State Fire Marshal Regulations, and Coastside Fire District Ordinance No. 2013-03, the applicant is required to install State Fire Marshal approved and listed smoke detectors which are hardwired, interconnected, and have battery backup. These detectors are required to be placed in each new and recondition sleeping room and at a point centrally located in the corridor or area giving access to each separate sleeping area. In existing sleeping rooms, areas may have battery powered smoke alarms. A minimum of one detector shall be placed on each floor. Smoke detectors shall be tested and approved prior to the building final.

23. Add Note: Escape or rescue windows shall have a minimum net clear openable area of 5.7 sq. ft. Five (5) sq. ft. allowed at grade. The minimum net clear openable height dimension shall be 24 inches. The net clear openable width dimension shall be 20 inches. Finished sill height shall be not more than 44 inches above the finished floor.
24. Occupancy Separation: As per the 2010 CBC, Section 406.1.4, a one-hour occupancy separation wall shall be installed with a solid-core, 20-minute fire rated, self-closing door assembly with smoke gasket between the garage and the residence. All electrical boxes installed in rated walls shall be metal or protected.
25. New attached garage shall meet occupancy separation requirements. Provide note/detail (CRC R302.6).
26. Address Numbers: As per Coastside Fire District Ordinance No. 2013-03, building identification shall be conspicuously posted and visible from the street. (TEMPORARY ADDRESS NUMBERS SHALL BE POSTED PRIOR TO COMBUSTIBLES BEING PLACED ON-SITE.) The letters/numerals for permanent address signs shall be 4 inches in height with a minimum 3/4-inch stroke. Such letters/numerals shall be internally illuminated and facing the direction of access. Finished height of bottom of address light unit shall be greater than or equal to 6 feet from finished grade. When the building is served by a long driveway or is otherwise obscured, a 6-inch by 18-inch green reflective metal sign with 3-inch reflective numbers/letters similar to Hy-Ko 911 or equivalent shall be placed at the entrance from the nearest public roadway. See Fire Ordinance for standard sign.
27. Roof Covering: As per Coastside Fire District Ordinance No. 2013-03, the roof covering of every new building or structure, and materials applied as part of a roof covering assembly, shall have a minimum fire rating of Class "B" or higher as defined in the current edition of the California Building Code.
28. Vegetation Management: As per the Coastside Fire District Ordinance No. 2013-03, the 2013 California Fire Code (CFC) and Public Resources Code 4291, a fuelbreak of defensible space is required around the perimeter of all structures to a distance of not less than 30 feet and may be required to a distance of 100 feet or to the property line. In a State Responsible Area (SRA), the fuelbreak is 100 feet or to the property line.
29. Trees located within the defensible space shall be pruned to remove dead and dying portions, and limbed up 6 to 10 feet above the ground. New trees planted in the defensible space shall be located no closer than 10 feet to adjacent trees when fully grown or at maturity.
30. Remove that portion of any existing tree, which extends within 10 feet of the outlet of a chimney or stovepipe or is within 5 feet of any structure.

31. Fire Access Roads: The applicant must have a maintained all-weather surface road for ingress and egress of fire apparatus. The San Mateo County Department of Public Works, the Coastside Fire District Ordinance No. 2013-03, and the California Fire Code shall set road standards. As per the 2013 CFC, dead-end roads exceeding 150 feet shall be provided with a turnaround in accordance with Half Moon Bay Fire District specifications. As per the 2007 CFC, Section Appendix D, road width shall not be less than 20 feet. Fire access roads shall be installed and made serviceable prior to combustibles being placed on the project site and maintained during construction. Approved signs and painted curbs or lines shall be provided and maintained to identify fire access roads and state the prohibition of their obstruction. If the road width does not allow parking on the street (20-foot road) and on-street parking is desired, an additional improved area shall be developed for that use.
32. Fire Hydrant: As per 2013 CFC, Appendix B and C, a fire district approved fire hydrant (Clow 960) must be located within 250 feet of the proposed single-family dwelling unit measured by way of drivable access. As per 2013 CFC, Appendix B, the hydrant must produce a minimum fire flow of 1,000 gallons per minute at 20 pounds per square inch residual pressure for 2 hours. Contact the local water purveyor for water flow details.
33. Show location of fire hydrant on a site plan. A fire hydrant is required within 250 feet of the building and flow a minimum of 1,000 gpm at 20 psi. This information is to be verified by the water purveyor in a letter initiated by the applicant and sent to the San Mateo County Fire/Cal-Fire or Coastside Fire District. If there is not a hydrant within 250 feet with the required flow, one will have to be installed at the applicant's expense.
34. Automatic Fire Sprinkler System: As per San Mateo County Building Standards and Coastside Fire District Ordinance No. 2103-03, the applicant is required to install an automatic fire sprinkler system throughout the proposed or improved dwelling and garage. All attic access locations will be provided with a pilot head on a metal upright. All areas that are accessible for storage purposes shall be equipped with fire sprinklers including closets and bathrooms. The only exception is small linen closets less than 24 sq. ft. with full depth shelving. The plans for this system must be submitted to the San Mateo County Planning and Building Department or the City of Half Moon Bay. A building permit will not be issued until plans are received, reviewed and approved. Upon submission of plans, the County or City will forward a complete set to the Coastside Fire District for review. The fee schedule for automatic fire sprinkler systems shall be in accordance with Half Moon Bay Ordinance No. 2006-01. Fees shall be paid prior to plan review if addition/remodel exceeds 50% valuation.
35. All fire conditions and requirements must be incorporated into your building plans prior to building permit issuance. It is your responsibility to notify your contractor, architect and engineer of these requirements.

Coastside County Water District

36. Prior to the issuance of a building permit, the applicant shall obtain a water service connection to include a backflow device.

Geotechnical Section

37. The applicant shall submit the geotechnical report prepared by Romig Engineers, Inc., dated September 12, 2014, for detailed review at the building stage.

DPA:fc – DPAZ0122_WFU.DOCX

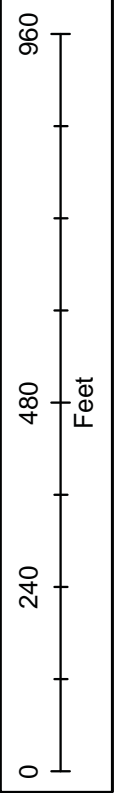

Source: Esri, DigitalGlobe, GeoEye, i-cubed, E, VICINITY MAP
 USGS, AEX, Getmapping, Aergrid, IGN, IGP, swisstopo, and the GIS User Community

San Mateo County Planning Commission Meeting

Owner/Applicant: Reza/McGriff

File Numbers: PLN2014-00133

Attachment: B

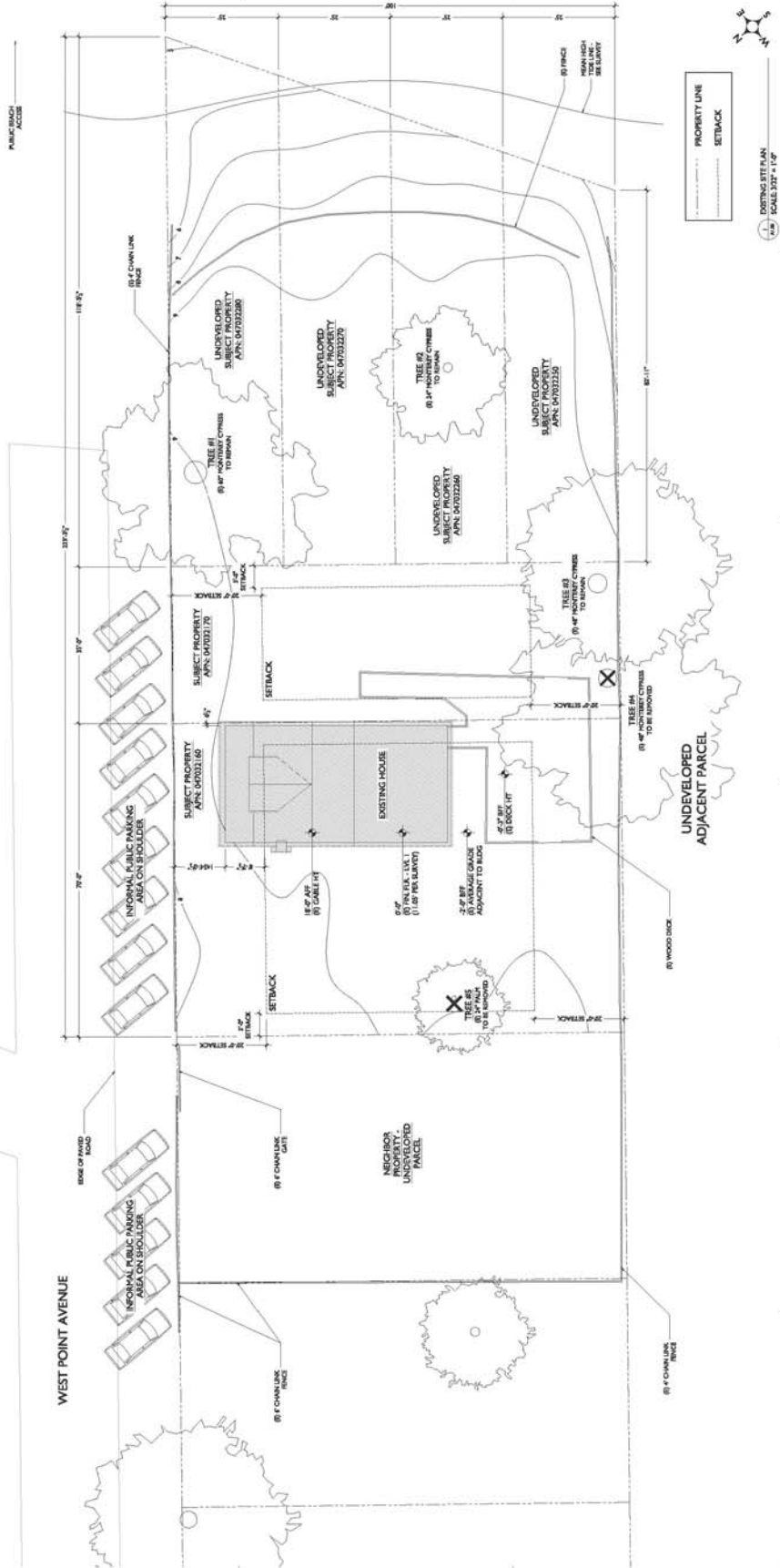
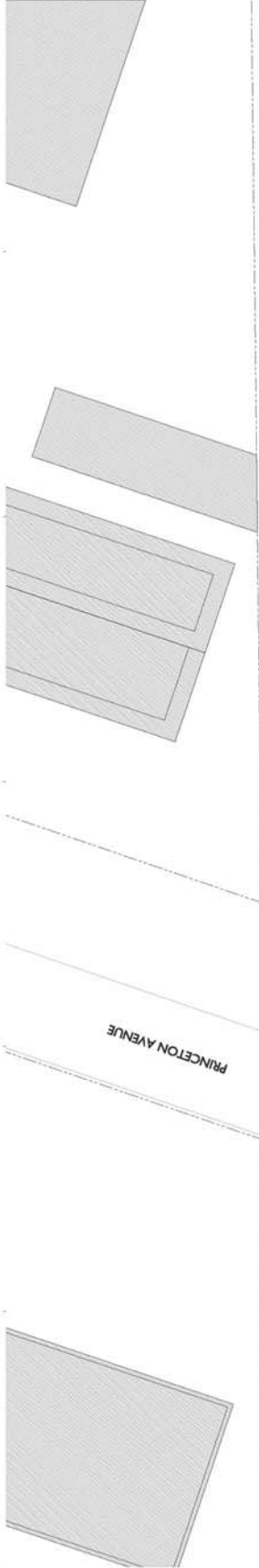

San Mateo County Planning Commission Meeting

Owner/Applicant: Reza/McGriff

Attachment: C

File Numbers: PLN2014-00133

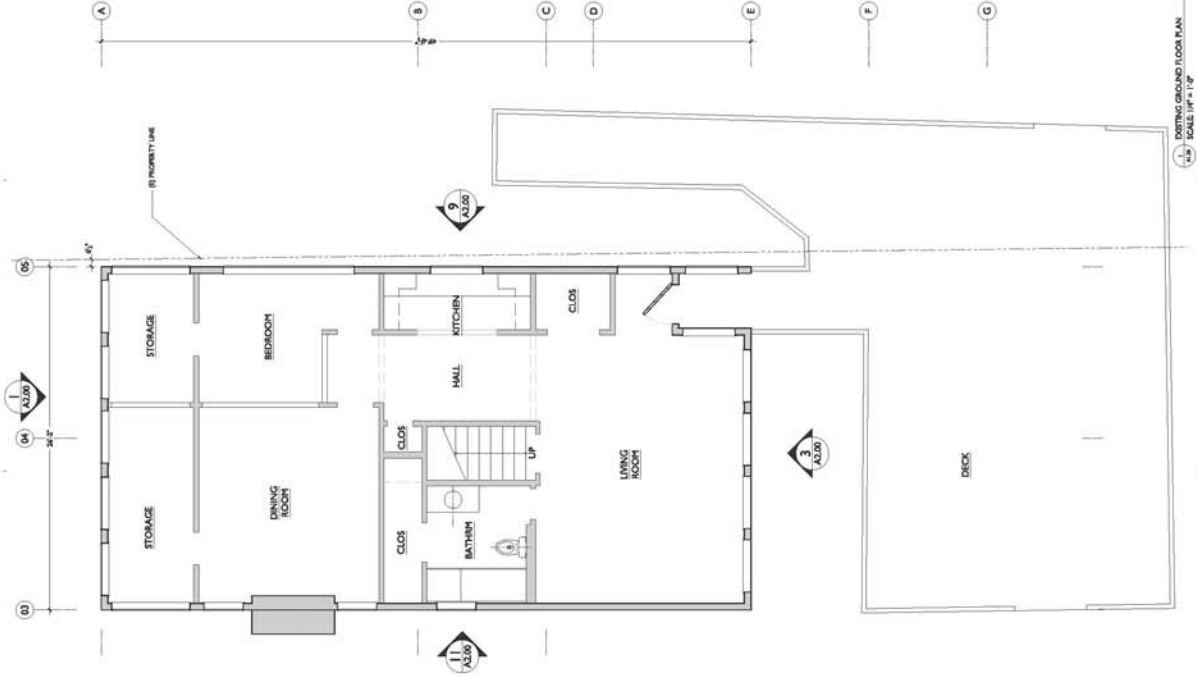
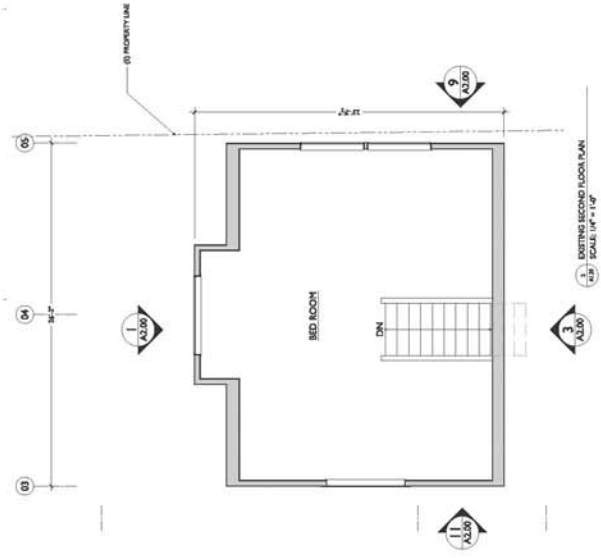

San Mateo County Planning Commission Meeting

Owner/Applicant: Reza/McGriff

File Numbers: PLN2014-00133

Attachment: C

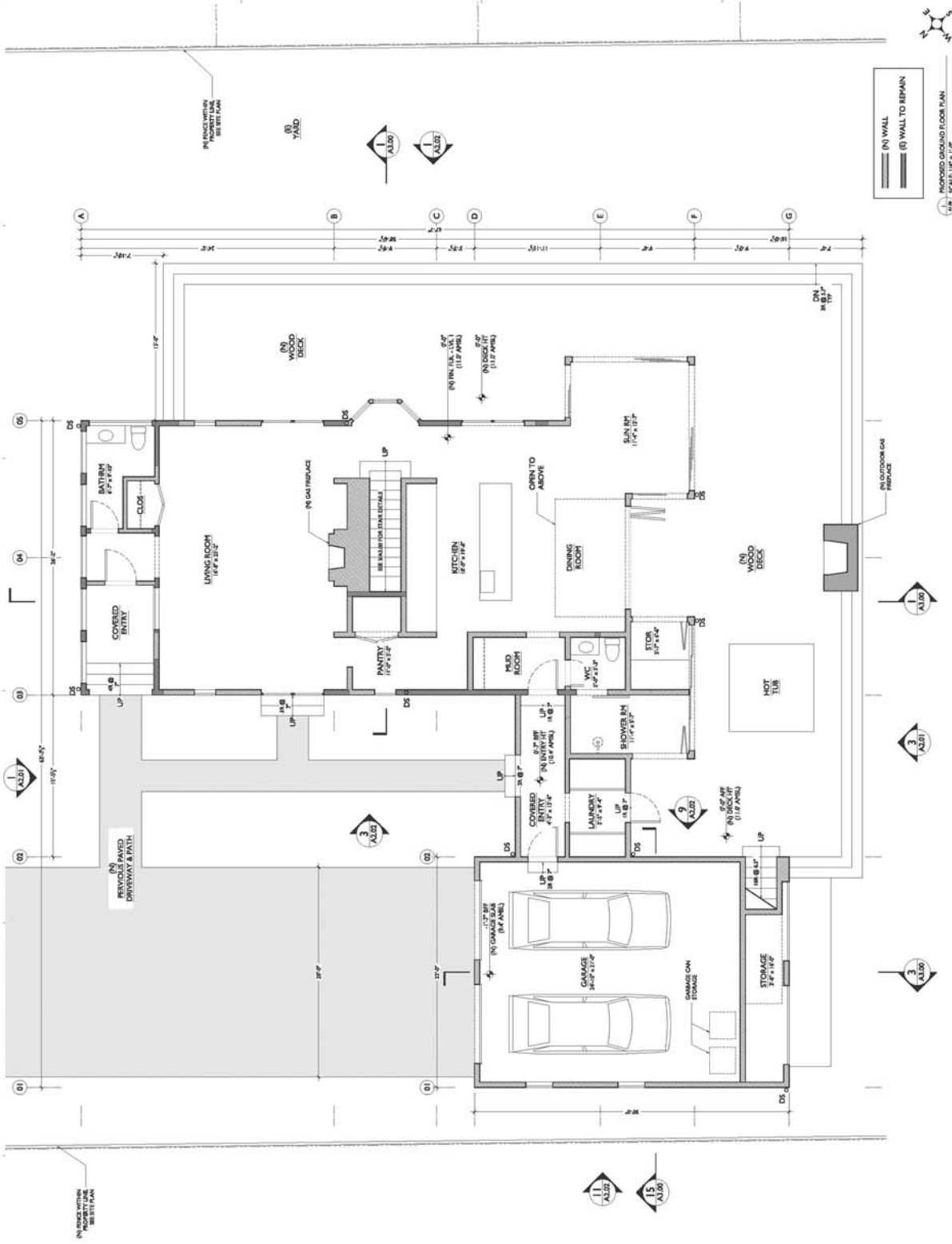

San Mateo County Planning Commission Meeting

Owner/Applicant: Reza/McGriff

File Numbers: PLN2014-00133

Attachment: C

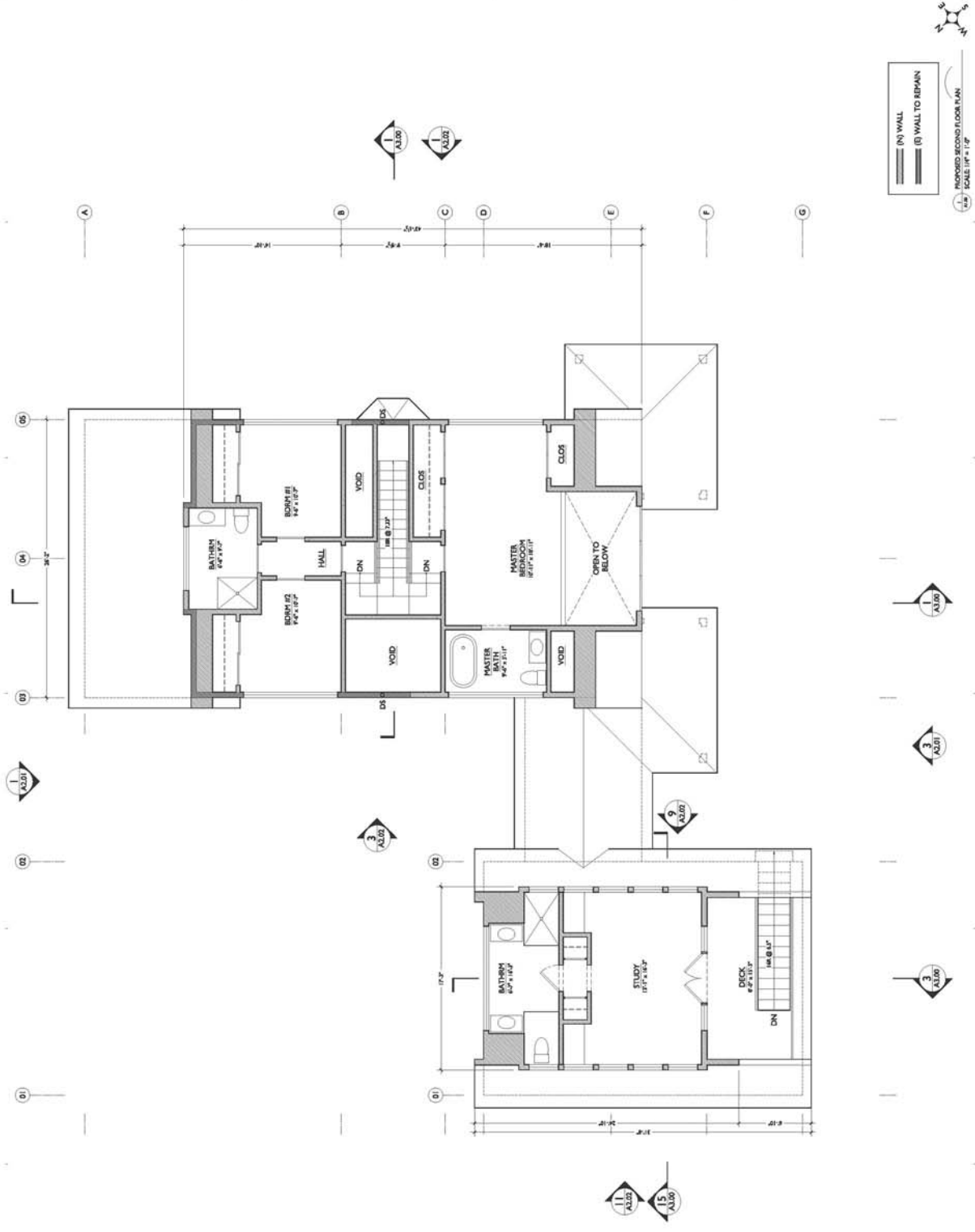

San Mateo County Planning Commission Meeting

Owner/Applicant: Reza/McGriff

File Numbers: PLN2014-00133

Attachment: C

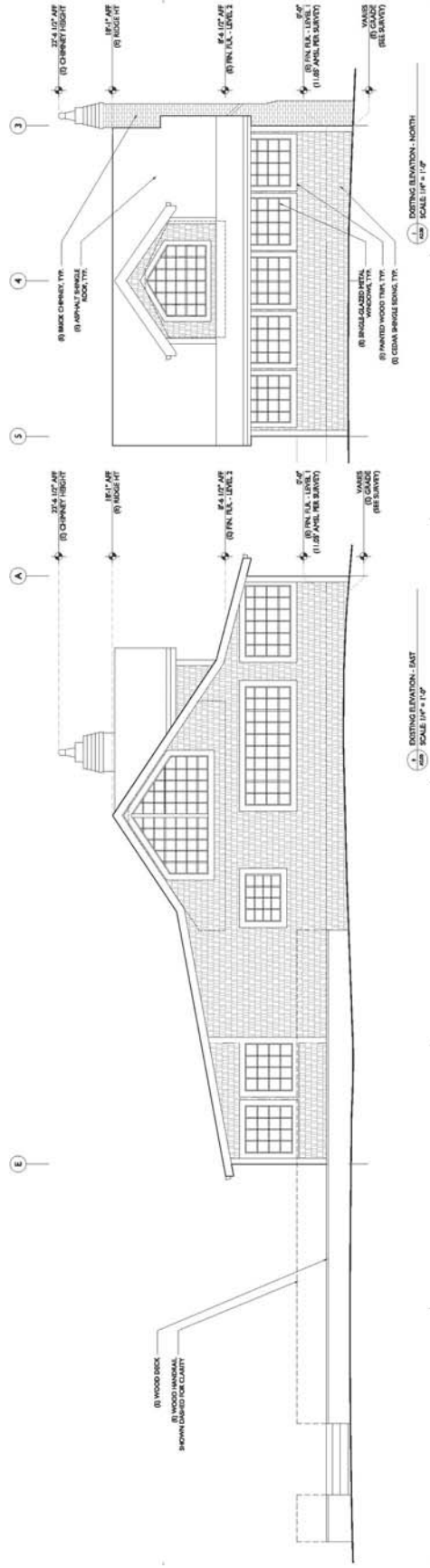
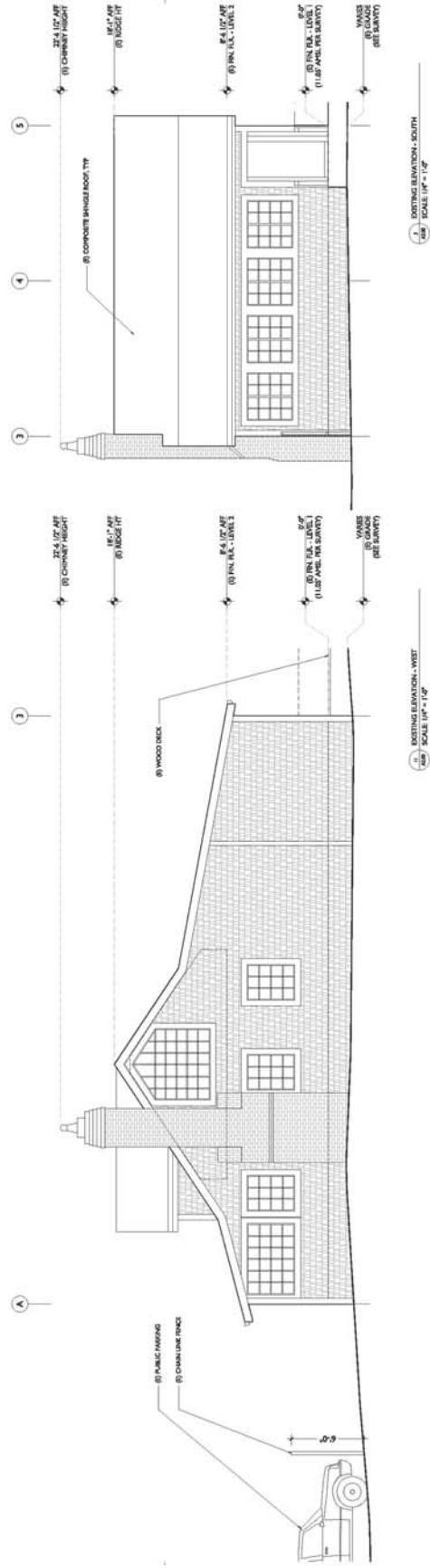

San Mateo County Planning Commission Meeting

Owner/Applicant: Reza/McGriff

File Numbers: PLN2014-00133

Attachment: C

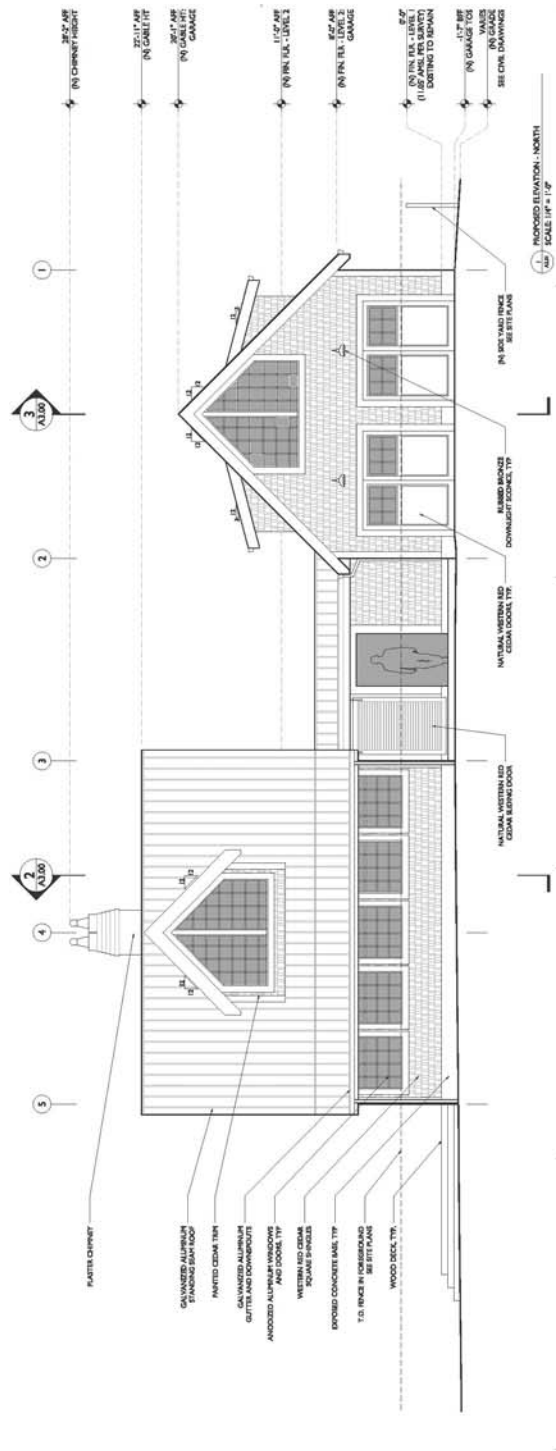
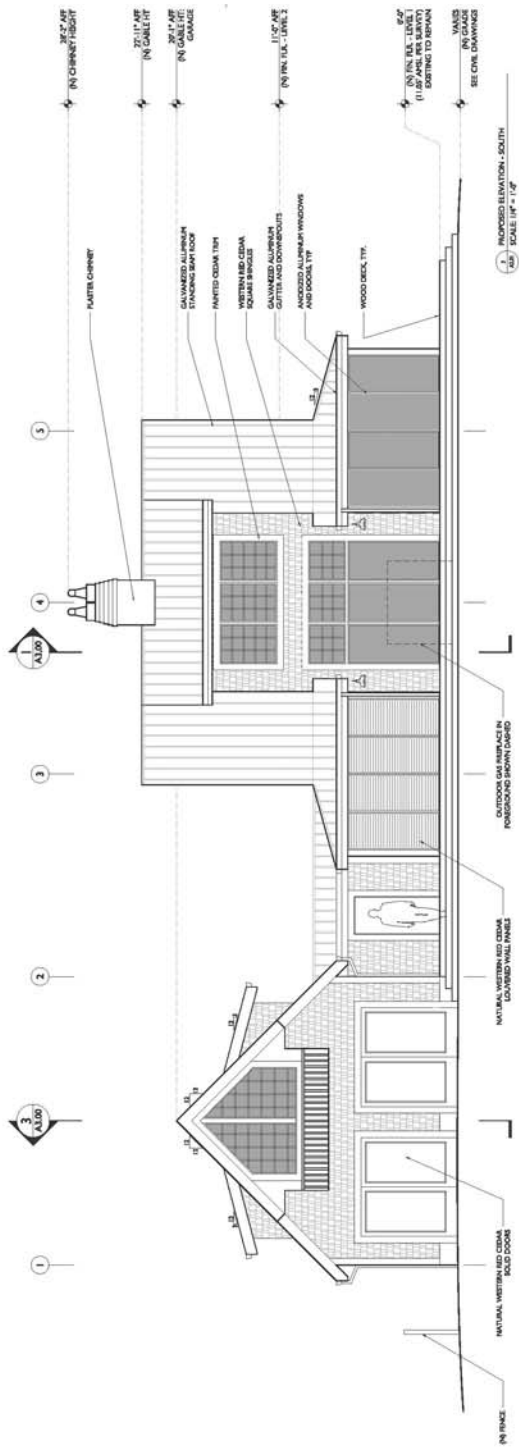

San Mateo County Planning Commission Meeting

Owner/Applicant: Reza/McGriff

File Numbers: PLN2014-00133

Attachment: C

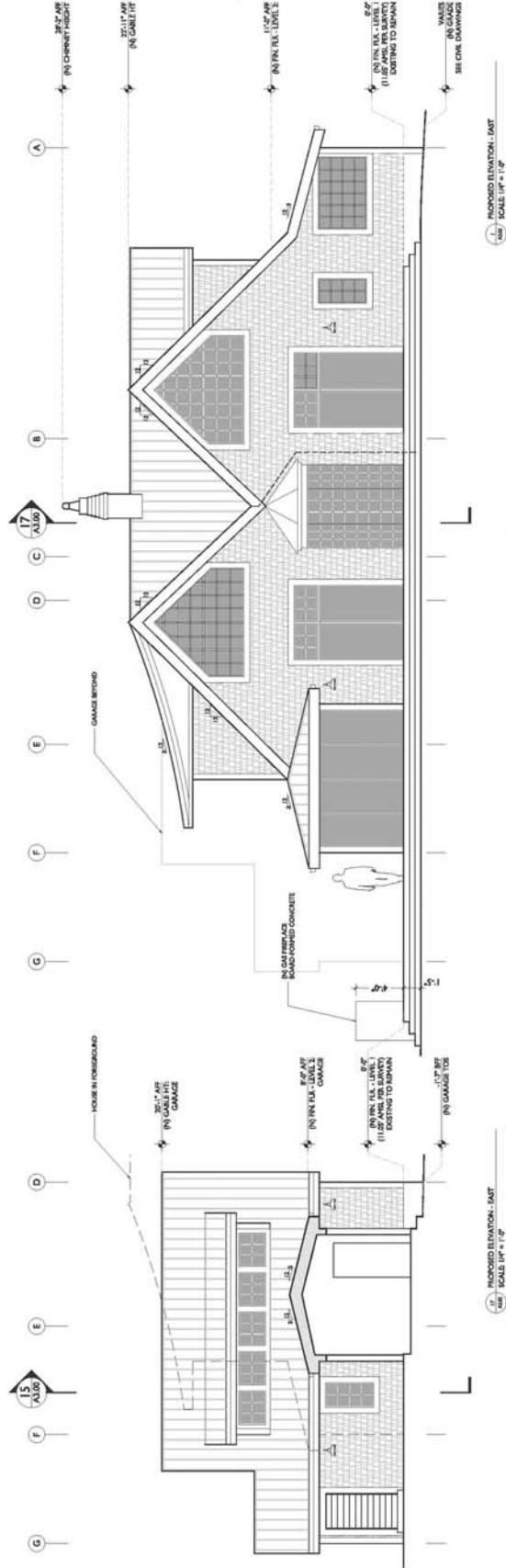
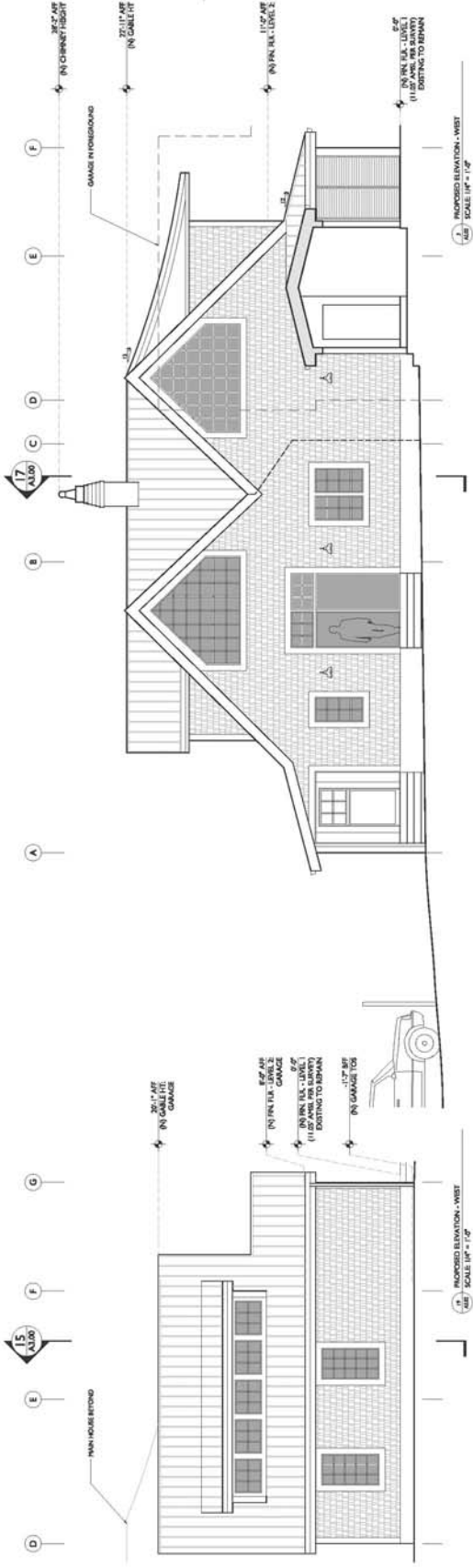

San Mateo County Planning Commission Meeting

Owner/Applicant: Reza/McGriff

File Numbers: PLN2014-00133

Attachment: C

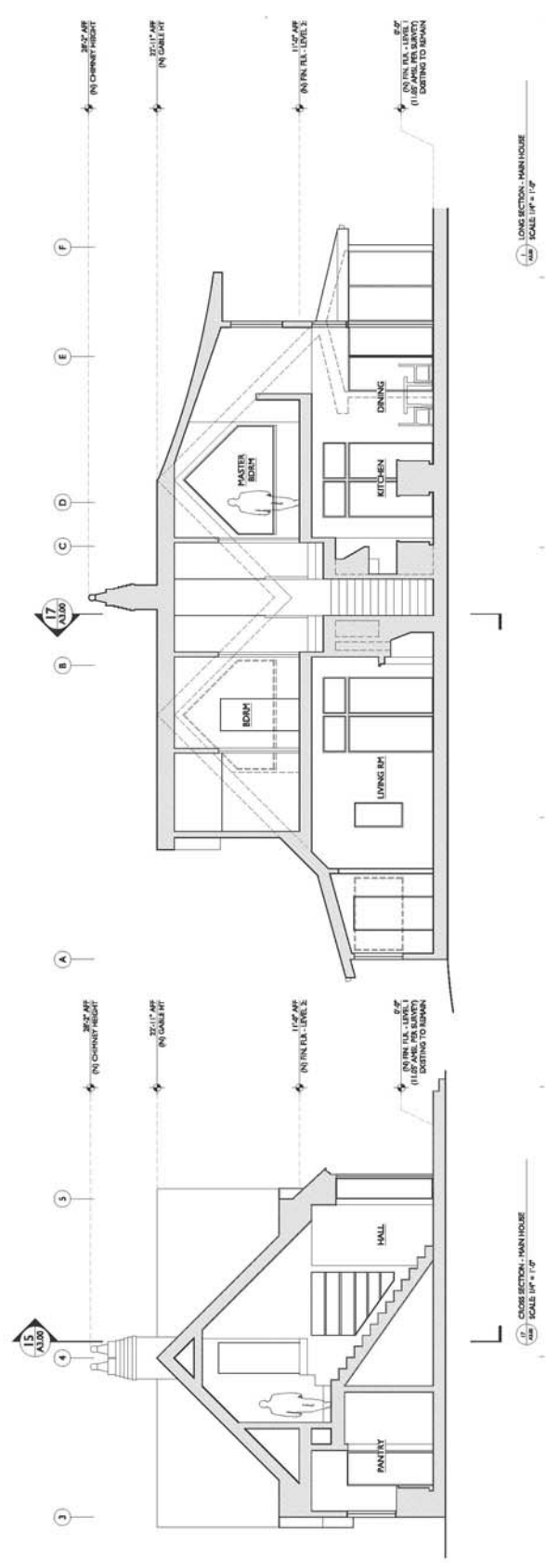
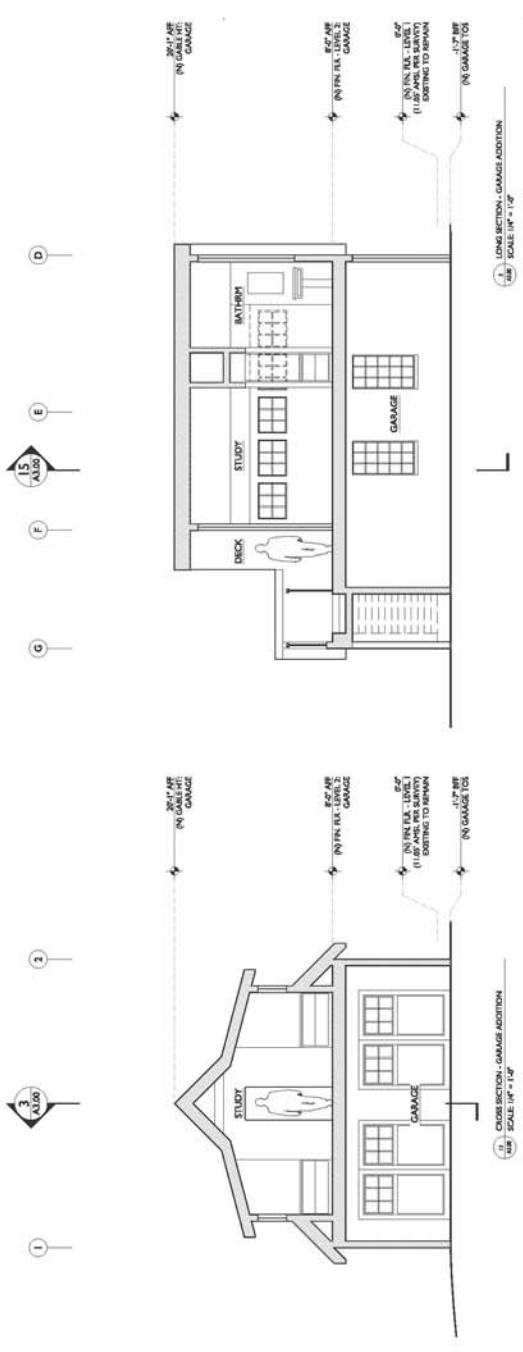

San Mateo County Planning Commission Meeting

Owner/Applicant: Reza/McGriff

File Numbers: PLN2014-00133

Attachment: C



County of San Mateo

Planning & Building Department

455 County Center, 2nd Floor
Redwood City, California 94063
650/363-4161 Fax: 650/363-4849

Mail Drop PLN122
plngbldg@smcgov.org
www.co.sanmateo.ca.us/planning

November 24, 2014

Benjamin McGriff
McGriff Architects
1475 - 15th Street
San Francisco, CA 94103

Planning Commission Meeting

PLN 2014-00133

Case

D

Attachment

Dear Mr. McGriff:

SUBJECT: Coastside Design Review Recommended Approval
115 West Point Avenue, Princeton
APN 047-032-160; County File No. PLN 2014-00133

At its meeting of July 10, 2014, the San Mateo County Coastside Design Review Committee considered your application for design review approval as part of a Non-Conforming Use Permit, Coastal Development Permit, and Lot Merger to allow construction of a 3,973 sq. ft. two-story addition that includes a 660 sq. ft. attached two-car garage, to an existing 1,888 sq. ft. two-story single-family residence, on an existing 7,000 sq. ft. legal parcel, where 5,000 sq. ft. is the required minimum, including a proposal to remove two (2) trees. The Non-Conforming Use Permit is required, pursuant to Section 6134.6 of the County Zoning Regulations, to allow enlargement of a non-conforming residential use in a non-residential (Waterfront) Zoning District. The Lot Merger is required to accommodate the proposed expansion. The project is appealable to the California Coastal Commission.

Based on the plans, application forms and accompanying materials submitted, the Coastside Design Review Committee recommended approval of your project based on and subject to the following findings and recommended conditions of approval:

FINDINGS

The Coastside Design Review Officer found that:

1. For the Environmental Review

This project is exempt from environmental review pursuant to the California Environmental Quality Act (CEQA), Section 15301, Class 1(e), relating to additions to existing structures.

The Coastside Design Review Committee found that:

2. For the Design Review

This project is in compliance with the Design Review Standards for One-Family Residential Development in the Midcoast, Section 6565.20 of the San Mateo County Zoning Regulations, specifically elaborated as follows:

- a. The proposed structure exhibits numerous articulated areas that include the connection of two structures with an enclosed entry hall, and architectural features such as gables and dormers (Section 6565.20(D)1.d and e).
- b. The proposed architectural style incorporates design elements such as gable roofs, dormers and well placed fenestrations framed with trims. As proposed, the home establishes itself as an example for future neighborhood renovations (Section 6565.20(D)2).
- c. The primary gable roof form serves both as a mitigating element for mass and bulk and maintains consistency with the existing home's roof form (Section 6565.20(D)3).
- d. As proposed and conditioned, the materials such as western red cedar shingles and earth-tone colors as the project's color scheme enhance the neighborhood and are compatible with coastal architecture in the area. Condition No. 4.a includes a recommendation to explore changing the exterior material at the entry corner hall to a translucent material, if deemed feasible (Section 6565.20(D)4).

RECOMMENDED CONDITIONS OF APPROVAL

Current Planning Section

1. The project shall be constructed in compliance with the plans recommended for approval by the Coastsides Design Review Committee on July 10, 2014. Any changes or revisions to the approved plans shall be submitted to the Design Review Officer, subject to review and approval, prior to implementation. Minor adjustments to the project may be approved by the Design Review Officer if they are consistent with the intent of and are in substantial conformance with this approval. Alternatively, the Design Review Officer may refer consideration of the revisions to the Coastsides Design Review Committee, with applicable fees to be paid.
2. The design review final approval shall be valid for five (5) years from the date of approval, in which time a building permit shall be issued and a completed inspection (to the satisfaction of the Building Inspector) shall have occurred within 180 days of its issuance. The design review approval may be extended by one 1-year increment with submittal of an application for permit extension and payment of applicable extension fees sixty (60) days prior to the expiration date.
3. The applicant shall include the recommended approval letter on the top pages of the building plans.
4. The applicant shall submit the following items and/or indicate the following on plans submitted for a building permit, as stipulated by the Coastsides Design Review Committee:
 - a. Exterior material at the entry corner hall may be of translucent material, if deemed feasible.

5. The applicant shall provide "finished floor elevation verification" to certify that the structure is actually constructed at the height shown on the submitted plans. The applicant shall have a licensed land surveyor or engineer establish a baseline elevation datum point in the vicinity of the construction site.
 - a. The applicant shall maintain the datum point so that it will not be disturbed by the proposed construction activities until final approval of the building permit.
 - b. This datum point and its elevation shall be shown on the submitted site plan. This datum point shall be used during construction to verify the elevation of the finished floors relative to the existing natural or to the grade of the site (finished grade).
 - c. Prior to Planning approval of the building permit application, the applicant shall also have the licensed land surveyor or engineer indicate on the construction plans: (1) the natural grade elevations at the significant corners (at least four) of the footprint of the proposed structure on the submitted site plan, and (2) the elevations of proposed finished grades.
 - d. In addition, (1) the natural grade elevations at the significant corners of the proposed structure, (2) the finished floor elevations, (3) the topmost elevation of the roof and (4) garage slab elevation must be shown on the plan, elevations, and cross-section (if one is provided).
 - e. Once the building is under construction, prior to the below floor framing inspection or the pouring of the concrete slab (as the case may be) for the lowest floor(s), the applicant shall provide to the Building Inspection Section a letter from the licensed land surveyor or engineer certifying that the lowest floor height--as constructed--is equal to the elevation specified for that floor in the approved plans. Similarly, certifications on the garage slab and the topmost elevation of the roof are required.
 - f. If the actual floor height, garage slab, or roof height--as constructed--is different than the elevation specified in the plans, then the applicant shall cease all construction and no additional inspections shall be approved until a revised set of plans is submitted to and subsequently approved by both the Building Official and Community Development Director.
6. During project construction, the applicant shall, pursuant to Chapter 4.100 of the San Mateo County Ordinance Code, minimize the transport and discharge of stormwater runoff from the construction site into storm drain systems and water bodies by:
 - a. Using filtration materials on storm drain covers to remove sediment from dewatering effluent.
 - b. Stabilizing all denuded areas and maintaining erosion control measures continuously between October 1 and April 30.

- c. Removing spoils promptly, and avoiding stockpiling of fill materials, when rain is forecast. If rain threatens, stockpiled soils and other materials shall be covered with a tarp or other waterproof material.
 - d. Storing, handling, and disposing of construction materials and wastes so as to avoid their entry to the storm drain system or water body.
 - e. Avoiding cleaning, fueling or maintaining vehicles on-site, except in an area designated to contain and treat runoff.
 - f. Limiting and timing application of pesticides and fertilizers to avoid polluting runoff.
7. The applicant shall include an erosion and sediment control plan on the plans submitted for the building permit. This plan shall identify the type and location of erosion control measures to be installed upon the commencement of construction in order to maintain the stability of the site and prevent erosion and sedimentation off-site.
 8. All new power and telephone utility lines from the street or nearest existing utility pole to the main dwelling and/or any other structure on the property shall be placed underground.
 9. The applicant shall apply for a building permit and shall adhere to all requirements from the Building Inspection Section, the Department of Public Works and the Coastside Fire Protection District.
 10. No site disturbance shall occur, including any grading or tree removal, until a building permit has been issued, and then only those trees approved for removal shall be removed.
 11. To reduce the impact of construction activities on neighboring properties, comply with the following:
 - a. All debris shall be contained on-site; a dumpster or trash bin shall be provided on-site during construction to prevent debris from blowing onto adjacent properties. The applicant shall monitor the site to ensure that trash is picked up and appropriately disposed of daily.
 - b. The applicant shall remove all construction equipment from the site upon completion of the use and/or need of each piece of equipment which shall include but not be limited to tractors, back hoes, cement mixers, etc.
 - c. The applicant shall ensure that no construction-related vehicles shall impede through traffic along the right-of-way on West Point Avenue. All construction vehicles shall be parked on-site outside the public right-of-way or in locations which do not impede safe access on West Point Avenue. There shall be no storage of construction vehicles in the public right-of-way.
 12. The exterior color samples submitted to the Coastside Design Review Committee are approved. Color verification shall occur in the field after the applicant has applied the approved materials and colors but before a final inspection has been scheduled.

13. Noise levels produced by the proposed construction activity shall not exceed the 80-dBA level at any one moment. Construction activities shall be limited to the hours from 7:00 a.m. to 6:00 p.m., Monday through Friday, and 9:00 a.m. to 5:00 p.m. on Saturday. Construction operations shall be prohibited on Sunday and any national holiday.

Building Inspection Section

14. The applicant shall apply for a building permit.

Department of Public Works

15. Prior to the issuance of the building permit or planning permit (for Provision C3 Regulated Projects), the applicant shall have prepared, by a registered civil engineer, a drainage analysis of the proposed project and submit it to the Department of Public Works for review and approval. The drainage analysis shall consist of a written narrative and a plan. The flow of the stormwater onto, over, and off the property shall be detailed on the plan and shall include adjacent lands as appropriate to clearly depict the pattern of flow. The analysis shall detail the measures necessary to certify adequate drainage. Post-development flows and velocities shall not exceed those that existed in the pre-developed state. Recommended measures shall be designed and included in the improvement plans and submitted to the Department of Public Works for review and approval.
16. Prior to the issuance of the building permit, the applicant shall submit a driveway "Plan and Profile," to the Department of Public Works, showing the driveway access to the parcel (garage slab) complying with County Standards for driveway slopes (not to exceed 20%) and to County Standards for driveways (at the property line) being the same elevation as the center of the access roadway. When appropriate, as determined by the Department of Public Works, this plan and profile shall be prepared from elevations and alignment shown on the roadway improvement plans. The driveway plan shall also include and show specific provisions and details for both the existing and the proposed drainage patterns and drainage facilities.
17. No proposed construction work within the County right-of-way shall begin until County requirements for the issuance of an encroachment permit, including review of the plans, have been met and an encroachment permit issued. Applicant shall contact a Department of Public Works Inspector 48 hours prior to commencing work in the right-of-way.
18. The applicant shall submit to the project planner a copy of the recorded Grant Deed(s) of only the parcels to be merged for review and approval prior to Planning Department approval.
19. Prior to the issuance of the building permit, the applicant will be required to provide payment of "roadway mitigation fees" based on the square footage (assessable space) of the proposed building per Ordinance No. 3277.
20. The applicant shall submit a permanent stormwater management plan in compliance with the County's Drainage Policy and NPDES requirements for review and approval by the Department of Public Works.

Coastside Fire Protection District

21. Smoke detectors which are hardwired: As per the California Building Code, State Fire Marshal Regulations, and Coastside Fire District Ordinance No. 2013-03, the applicant is required to install State Fire Marshal approved and listed smoke detectors which are hardwired, interconnected, and have battery backup. These detectors are required to be placed in each new and recondition sleeping room and at a point centrally located in the corridor or area giving access to each separate sleeping area. In existing sleeping rooms, areas may have battery powered smoke alarms. A minimum of one detector shall be placed on each floor. Smoke detectors shall be tested and approved prior to the building final.
22. Add note: Escape or rescue windows shall have a minimum net clear openable area of 5.7 sq. ft. Five (5) sq. ft. allowed at grade. The minimum net clear openable height dimension shall be 24 inches. The net clear openable width dimension shall be 20 inches. Finished sill height shall be not more than 44 inches above the finished floor.
23. Occupancy Separation: As per the 2013 CBC, Section 406.3.4, a one-hour occupancy separation wall shall be installed with a solid core, 20-minute fire rated, self-closing door assembly with smoke gasket between the garage and the residence. All electrical boxes installed in rated walls shall be metal or protected.
24. New attached garage to meet occupancy separation requirements. Provide note/detail. CRC R302.6
25. Address Numbers: As per Coastside Fire District Ordinance No. 2013-03, building identification shall be conspicuously posted and visible from the street. (TEMPORARY ADDRESS NUMBERS SHALL BE POSTED PRIOR TO COMBUSTIBLES BEING PLACED ON-SITE.) The letters/numerals for permanent address signs shall be 4 inches in height with a minimum 3/4-inch stroke. Such letters/numerals shall be internally illuminated and facing the direction of access. Finished height of bottom of address light unit shall be greater than or equal to 6 feet from finished grade. When the building is served by a long driveway or is otherwise obscured, a 6-inch by 18-inch green reflective metal sign with 3-inch reflective numbers/letters similar to Hy-Ko 911 or equivalent shall be placed at the entrance from the nearest public roadway. See Fire Ordinance for standard sign.
26. Roof Covering: As per Coastside Fire District Ordinance No. 2013-03, the roof covering of every new building or structure, and materials applied as part of a roof covering assembly, shall have a minimum fire rating of Class "B" or higher as defined in the current edition of the California Building Code.
27. Vegetation management: As per the Coastside Fire District Ordinance No. 2013-03, the 2013 California Fire Code (CFC) and Public Resources Code 4291, a fuelbreak of defensible space is required around the perimeter of all structures to a distance of not less than 30 feet and may be required to a distance of 100 feet or to the property line. In SRA (State Responsible Area), the fuelbreak is 100 feet or to the property line.

28. Trees located within the defensible space shall be pruned to remove dead and dying portions, and limbed up 6 to 10 feet above the ground. New trees planted in the defensible space shall be located no closer than 10 feet to adjacent trees when fully grown or at maturity.
29. Remove that portion of any existing tree, which extends within 10 feet of the outlet of a chimney or stovepipe or is within 5 feet of any structure.
30. Fire Access Roads: The applicant must have a maintained all-weather surface road for ingress and egress of fire apparatus. The San Mateo County Department of Public Works, the Coastside Fire District Ordinance No. 2013-03, and the California Fire Code shall set road standards. As per the 2013 CFC, dead-end roads exceeding 150 feet shall be provided with a turnaround in accordance with Half Moon Bay Fire District specifications. As per the 2007 CFC, Section Appendix D, road width shall not be less than 20 feet. Fire access roads shall be installed and made serviceable prior to combustibles being placed on the project site and maintained during construction. Approved signs and painted curbs or lines shall be provided and maintained to identify fire access roads and state the prohibition of their obstruction. If the road width does not allow parking on the street (20-foot road) and on-street parking is desired, an additional improved area shall be developed for that use.
31. Fire Hydrant: As per 2013 CFC, Appendix B and C, a fire district approved fire hydrant (Clow 960) must be located within 250 feet of the proposed single-family dwelling unit measured by way of drivable access. As per 2013 CFC, Appendix B, the hydrant must produce a minimum fire flow of 1,000 gallons per minute at 20 pounds per square inch residual pressure for 2 hours. Contact the local water purveyor or water flow details.
32. Show the location of fire hydrant on a site plan. A fire hydrant is required within 250 feet of the building and flow a minimum of gallons per minute at 20 pounds per square inch. This information is to be verified by the water purveyor in a letter initiated by the applicant and sent to San Mateo County Fire/Cal-Fire or Coastside Fire District. If there is not a hydrant within 250 feet with the required flow, one will have to be installed at the applicant's expense.
33. Automatic Fire Sprinkler System: As per San Mateo County Building Standards and Coastside Fire District Ordinance No. 2103-03, the applicant is required to install an automatic fire sprinkler system throughout the proposed improved dwelling and garage. All attic access locations will be provided with a pilot head on a metal upright. All areas that are accessible for storage purposes shall be equipped with fire sprinklers including closets and bathrooms. The only exception is small linen closets less than 24 sq. ft. with full depth shelving. The plans for this system must be submitted to the San Mateo County Planning and Building Department or the City of Half Moon Bay. A building permit will not be issued until plans are received, reviewed and approved. Upon submission of plans, the County or City will forward a complete set to the Coastside Fire District for review. The fee schedule for automatic fire sprinkler systems shall be in accordance with Half Moon Bay Ordinance No. 2006-01. Fees shall be paid prior to plan review if addition/remodel exceeds 50% valuation.

34. All fire conditions and requirements must be incorporated into your building plans prior to building permit issuance. It is your responsibility to notify your contractor, architect and engineer of these requirements.

Coastside County Water District

35. Prior to the issuance of a building permit, the applicant shall obtain a water service connection to include a backflow device.

Geotechnical Section

36. The applicant shall submit a new or updated geotechnical report at the building application stage.

Please note that the decision of the Coastside Design Review Committee is a recommendation regarding the project's compliance with Design Review Standards, not the final decision on this project, which requires a Non-Conforming Use Permit, Coastal Development Permit, and Lot Merger. The decision on the Non-Conforming Use Permit, Coastal Development Permit, and Lot Merger will take place at a later date. For more information, please contact the project planner, Dennis P. Aguirre, at 650/363-1867, or by email at daguirre@smcgov.org.

Sincerely,

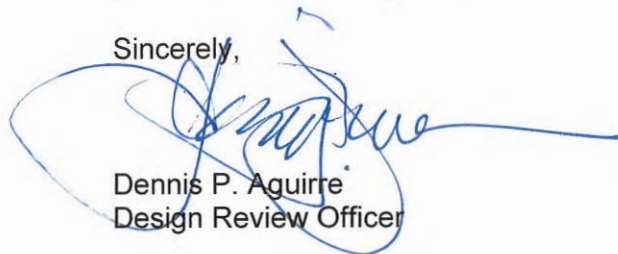

Dennis P. Aguirre
Design Review Officer

DPA:pac – DPAY1065_WPN.DOCX

Attachment

cc: Diane Whitaker, Architect
Willard Williams, Architect
Annette Merriman, Community Representative (Alternate)

COUNTY OF SAN MATEO, PLANNING AND BUILDING DEPARTMENT

**NOTICE OF INTENT TO ADOPT
NEGATIVE DECLARATION**

A notice, pursuant to the California Environmental Quality Act of 1970, as amended (Public Resources Code 21,000, et seq.), that the following project: Malek Single-Family Residence Addition, when adopted and implemented, will not have a significant impact on the environment.

FILE NO.: PLN 2014-00133

OWNER/APPLICANT: Malek Reza/Benjamin McGriff

ASSESSOR'S PARCEL NOS.: 047-032-160, and -170

LOCATION: 115 West Point Avenue, Princeton

Planning Commission Meeting
PLN 2014-00133
Case
E
Attachment

PROJECT DESCRIPTION: The applicant is requesting approval of a Non-Conforming Use Permit, Coastal Development Permit, and Design Review Permit, pursuant to Sections 6134.6, 6328.4 and 6565.3 of the San Mateo County Zoning Regulations, respectively, to allow construction of a 3,973 sq. ft. 2-story addition that includes a 660 sq. ft. attached 2-car garage, to an existing 1,888 sq. ft. 2-story single-family residence, on an existing 13,500 sq. ft. legal parcel, including a proposal to remove two (2) trees. The Non-Conforming Use Permit is required to allow enlargement of a non-conforming residential use in a non-residential (Waterfront) zoning district. The project is appealable to the California Coastal Commission.

FINDINGS AND BASIS FOR A NEGATIVE DECLARATION

The Current Planning Section has reviewed the initial study for the project and, based upon substantial evidence in the record, finds that:

1. The project, as proposed, will not adversely affect water or air quality or increase noise levels substantially.
2. The project, as proposed, will not have adverse impacts on the flora or fauna of the area.
3. The project, as proposed, will not degrade the aesthetic quality of the area.
4. The project, as proposed, will not have adverse impacts on traffic or land use.
5. In addition, the project, as proposed, will not:
 - a. Create impacts which have the potential to degrade the quality of the environment.
 - b. Create impacts which achieve short-term to the disadvantage of long-term environmental goals.

- c. Create impacts for a project which are individually limited, but cumulatively considerable.
- d. Create environmental effects which will cause substantial adverse effects on human beings, either directly or indirectly.

The County of San Mateo has, therefore, determined that the environmental impact of the project is less than significant.

MITIGATION MEASURE included in the project to avoid potentially significant effects:

Mitigation Measure 1: Complete a design-level geotechnical investigation including subsurface exploration to address the geotechnical conditions at the site and to provide earthwork guidelines and foundation design criteria for the proposed remodeling and addition to the residence.

RESPONSIBLE AGENCY CONSULTATION: None.

INITIAL STUDY: The San Mateo County Current Planning Section has reviewed the Environmental Evaluation of this project and has found that the probable environmental impacts are less than significant. A copy of the initial study is attached.

REVIEW PERIOD: January 21, 2015 to February 9, 2015

All comments regarding the correctness, completeness, or adequacy of this Negative Declaration must be received by the County Planning and Building Department, 455 County Center, Second Floor, Redwood City, no later than **5:00 p.m., February 9, 2015.**

CONTACT PERSON

Dennis P. Aguirre
Project Planner, 650/363-1867
daguirre@smcgov.org



Dennis P. Aguirre, Project Planner

DPA:fc – DPAZ0095_WPH.DOCX
FRM00013(click).doc (1/11/07)

County of San Mateo
Planning and Building Department

**INITIAL STUDY
ENVIRONMENTAL EVALUATION CHECKLIST**
(To Be Completed by Planning Department)

1. **Project Title:** Malek Single-Family Residence Addition
2. **County File Number:** PLN 2014-00133
3. **Lead Agency Name and Address:** County of San Mateo Planning and Building Department, 455 County Center, Second Floor, Redwood City, CA 94063
4. **Contact Person and Phone Number:** Dennis P. Aguirre, Project Planner, 650/363-1867
5. **Project Location:** 155 West Point Avenue, Princeton
6. **Assessor's Parcel Number and Size of Parcels:** 047-032-160, and -170; 13,500 sq. ft.
7. **Project Sponsor's Name and Address:** Benjamin McGriff, 1475 - 15th Street, San Francisco
8. **General Plan Designation:** General Industrial
9. **Zoning:** W/DR/CD (Waterfront District/Design Review/Coastal Development)
10. **Description of the Project:** The applicant is requesting approval of a Non-Conforming Use Permit, Coastal Development Permit, and Design Review Permit, pursuant to Sections 6134.6, 6328.4 and 6565.3 of the San Mateo County Zoning Regulations, respectively, to allow construction of a 3,973 sq. ft. 2-story addition that includes a 660 sq. ft. attached 2-car garage, to an existing 1,888 sq. ft. 2-story single-family residence, on an existing 13,500 sq. ft. legal parcel, including a proposal to remove two (2) trees. The Non-Conforming Use Permit is required to allow enlargement of a non-conforming residential use in a non-residential (Waterfront) zoning district. The project is appealable to the California Coastal Commission.
11. **Surrounding Land Uses and Setting:** The site is relatively flat in topography and is located in a general industrial area predominantly characterized by warehouses and similar other uses, most of which support the local established small harbor business economy. One other single-family residence is located on this street north of the subject site. The site is accessed via West Point Avenue. Pillar Point Harbor, Pillar Point Marsh and the shoreline beach area are within the immediate area of the site. The subject parcel is also located toward the southern end of West Point Avenue immediately adjacent to a designated beach access point.
12. **Other Public Agencies Whose Approval is Required:** None

ENVIRONMENTAL FACTORS POTENTIALLY AFFECTED

There are no environmental factors that would be potentially be affected by this project, involving at least one impact that is a "Potentially Significant Impact" or "Significant Unless Mitigated", as indicated by the checklist on the following pages.

	Aesthetics		Climate Change		Population/Housing
	Agricultural and Forest Resources		Hazards and Hazardous Materials		Public Services
	Air Quality		Hydrology/Water Quality		Recreation
	Biological Resources		Land Use/Planning		Transportation/Traffic
	Cultural Resources		Mineral Resources		Utilities/Service Systems
X	Geology/Soils		Noise		Mandatory Findings of Significance

EVALUATION OF ENVIRONMENTAL IMPACTS

1. A brief explanation is required for all answers except "No Impact" answers that are adequately supported by the information sources a lead agency cites. A "No Impact" answer is adequately supported if the referenced information sources show that the impact simply does not apply to projects like the one involved (e.g., the project falls outside a fault rupture zone). A "No Impact" answer should be explained where it is based on project-specific factors as well as general standards (e.g., the project will not expose sensitive receptors to pollutants, based on a project-specific screening analysis).
2. All answers must take account of the whole action involved, including off-site as well as on-site, cumulative as well as project-level, indirect as well as direct, and construction as well as operational impacts.
3. Once the lead agency has determined that a particular physical impact may occur, then the checklist answers must indicate whether the impact is potentially significant, less than significant with mitigation, or less than significant. "Potentially Significant Impact" is appropriate if there is substantial evidence that an effect may be significant. If there are one or more "Potentially Significant Impact" entries when the determination is made, an EIR is required.
4. "Negative Declaration: Less Than Significant with Mitigation Incorporated" applies where the incorporation of mitigation measures has reduced an effect from "Potentially Significant Impact" to a "Less Than Significant Impact." The lead agency must describe the mitigation measures, and briefly explain how they reduce the effect to a less than significant level (mitigation measures from "Earlier Analyses," as described in 5. below, may be cross-referenced).
5. Earlier analyses may be used where, pursuant to the tiering, program EIR, or other CEQA process, an effect has been adequately analyzed in an earlier EIR or negative declaration (Section 15063(c)(3)(D)). In this case, a brief discussion should identify the following:
 - a. Earlier Analysis Used. Identify and state where they are available for review.

- b. Impacts Adequately Addressed. Identify which effects from the above checklist were within the scope of and adequately analyzed in an earlier document pursuant to applicable legal standards, and state whether such effects were addressed by mitigation measures based on the earlier analysis.
 - c. Mitigation Measures. For effects that are "Less Than Significant with Mitigation Measures Incorporated," describe the mitigation measures which were incorporated or refined from the earlier document and the extent to which they address site-specific conditions for the project.
6. Lead agencies are encouraged to incorporate into the checklist references to information sources for potential impacts (e.g., general plans, zoning ordinances). Reference to a previously prepared or outside document should, where appropriate, include a reference to the page or pages where the statement is substantiated.
 7. Supporting Information Sources. Sources used or individuals contacted should be cited in the discussion.

1. AESTHETICS. Would the project:				
	<i>Potentially Significant Impacts</i>	<i>Significant Unless Mitigated</i>	<i>Less Than Significant Impact</i>	<i>No Impact</i>
1.a. Have a significant adverse effect on a scenic vista, views from existing residential areas, public lands, water bodies, or roads?			X	
<p>Discussion: The expansion of the existing single-family residence will not intrude into any scenic vista. The project site is not located within any State or County Scenic Corridor nor is it in a residential zoning district. The Coastside Design Review Committee (CDRC) considered the project at its July 10, 2014 meeting, and recommended approval, as submitted. The residence would not be visible from nearby public beach areas. The adjacent undeveloped parcels south of the site consisting of mature Monterey cypress trees visually buffer the residence from the beach area. The site is visible from West Point Avenue which is not a scenic road.</p> <p>Source: Project Plans, Field Observation and County GIS Resource Maps.</p>				
1.b. Significantly damage or destroy scenic resources, including, but not limited to, trees, rock outcroppings, and historic buildings within a state scenic highway?				X
<p>Discussion: The project is not located within a State Scenic Highway.</p> <p>Source: Project Plans, Field Observation and County GIS Resource Maps.</p>				

1.c. Significantly degrade the existing visual character or quality of the site and its surroundings, including significant change in topography or ground surface relief features, and/or development on a ridgeline?				X
<p>Discussion: The project does not involve a change in existing site topography, as the site is flat. The project will enhance the visual character of the neighborhood, as supported by the recommendation of approval from the CDRC.</p> <p>Source: Project Plans and Field Observation.</p>				
1.d. Create a new source of significant light or glare that would adversely affect day or nighttime views in the area?			X	
<p>Discussion: As the project involves the installation of exterior lighting fixtures that are downward directed, as required by the Design Review standards, no significant source of light and glare will be created that would affect the views in the area.</p> <p>Source: Project Plans and San Mateo County Zoning Regulations.</p>				
1.e. Be adjacent to a designated Scenic Highway or within a State or County Scenic Corridor?				X
<p>Discussion: N/A. The site is not located adjacent to a Scenic Highway or within a State or County Scenic Corridor.</p> <p>Source: Project Plans and Field Observation.</p>				
1.f. If within a Design Review District, conflict with applicable General Plan or Zoning Ordinance provisions?			X	
<p>Discussion: The project is subject to the approval of a Non-Conforming Use Permit, pursuant to Section 6134.6 of the San Mateo County Zoning Regulations. The project meets the required findings for the enlargement of the existing non-conforming residential use since it will not result in a significant adverse impact on coastal resources, or be detrimental to the public welfare or injurious to property or improvements in the neighborhood.</p> <p>Source: Project Plans and Field Observation.</p>				
1.g. Visually intrude into an area having natural scenic qualities?			X	
<p>Discussion: Reference response to Section 1.a., above.</p> <p>Source: Project Plans and Field Observation.</p>				

<p>2. AGRICULTURAL AND FOREST RESOURCES. In determining whether impacts to agricultural resources are significant environmental effects, lead agencies may refer to the California Agricultural Land Evaluation and Site Assessment Model (1997) prepared by the California Department of Conservation as an optional model to use in assessing impacts on agriculture and farmland. In determining whether impacts to forest resources, including timberland, are significant environmental effects, lead agencies may refer to information compiled by the California Department of Forestry and Fire Protection regarding the State's inventory of forestland, including the Forest and Range Assessment Project and the Forest Legacy Assessment Project; and forest carbon measurement methodology provided in Forest Protocols adopted by the California Air Resources Board. Would the project:</p>					
		<i>Potentially Significant Impacts</i>	<i>Significant Unless Mitigated</i>	<i>Less Than Significant Impact</i>	<i>No Impact</i>
2.a.	For lands outside the Coastal Zone, convert Prime Farmland, Unique Farmland, or Farmland of Statewide Importance (Farmland) as shown on the maps prepared pursuant to the Farmland Mapping and Monitoring Program of the California Resources Agency, to non-agricultural use?				X
<p>Discussion: N/A. The project site does not contain farmland and is not located in an agricultural zoning district.</p> <p>Source: Project Plans and Field Observation.</p>					
2.b.	Conflict with existing zoning for agricultural use, an existing Open Space Easement, or a Williamson Act contract?				X
<p>Discussion: Reference response to Section 2.a., above.</p> <p>Source: Project Plans and Field Observation.</p>					
2.c.	Involve other changes in the existing environment which, due to their location or nature, could result in conversion of Farmland to non-agricultural use or conversion of forestland to non-forest use?				X
<p>Discussion: Reference response to Section 2.a., above.</p> <p>Source: Project Plans and Field Observation.</p>					
2.d.	For lands within the Coastal Zone, convert or divide lands identified as Class I or Class II Agriculture Soils and Class III Soils rated good or very good for artichokes or Brussels sprouts?				X

Discussion: Reference response to Section 2.a., above.					
Source: Project Plans and Field Observation.					
2.e.	Result in damage to soil capability or loss of agricultural land?				X
Discussion: Reference response to Section 2.a., above.					
Source: Project Plans and Field Observation.					
2.f.	Conflict with existing zoning for, or cause rezoning of, forestland (as defined in Public Resources Code Section 12220(g)), timberland (as defined by Public Resources Code Section 4526), or timberland zoned Timberland Production (as defined by Government Code Section 51104(g))? <i>Note to reader: This question seeks to address the economic impact of converting forestland to a non-timber harvesting use.</i>				X
Discussion: N/A. The project site is not located in a forestland/timberland area.					
Source: Project Plans and Field Observation.					

3. AIR QUALITY. Where available, the significance criteria established by the applicable air quality management or air pollution control district may be relied upon to make the following determinations. Would the project:					
		<i>Potentially Significant Impacts</i>	<i>Significant Unless Mitigated</i>	<i>Less Than Significant Impact</i>	<i>No Impact</i>
3.a.	Conflict with or obstruct implementation of the applicable air quality plan?			X	
Discussion: The construction of the addition may result in temporary generation of pollutants related to construction. However, the project would not result in the generation of a significant level of pollutants. Section 2-1-113 (<i>Exemption, Sources and Operations</i>) of the General Requirements of the Bay Area Air Quality Management District exempts sources of air pollution associated with construction of a single-family dwelling used solely for residential purposes, as well as road construction. No mitigation measures are necessary.					
Source: Bay Area Air Quality Management District (BAAQMD) Regulation 2, Rule 1: General Requirements.					
3.b.	Violate any air quality standard or contribute significantly to an existing or projected air quality violation?				X

Discussion: Reference response to Section 3.a., above.					
Source: BAAQMD Regulation 2, Rule 1: General Requirements.					
3.c.	Result in a cumulatively considerable net increase of any criteria pollutant for which the project region is non-attainment under an applicable Federal or State ambient air quality standard (including releasing emissions which exceed quantitative thresholds for ozone precursors)?				X
Discussion: Reference response to Section 3.a., above.					
Source: BAAQMD Regulation 2, Rule 1: General Requirements.					
3.d.	Expose sensitive receptors to significant pollutant concentrations, as defined by BAAQMD?				X
Discussion: Reference response to Section 3.a., above.					
Source: BAAQMD Regulation 2, Rule 1: General Requirements.					
3.e.	Create objectionable odors affecting a significant number of people?				X
Discussion: While project construction for the residential upgrade may create temporary construction-related odors, the project would not result in any permanent odors, nor would temporary odors affect a significant number of people as the project is located on private property and is not located within a single-family residential neighborhood.					
Source: Project Application/Plans.					
3.f.	Generate pollutants (hydrocarbon, thermal odor, dust or smoke particulates, radiation, etc.) that will violate existing standards of air quality on-site or in the surrounding area?				X
Discussion: Reference response to Section 3.a., above.					
Source: BAAQMD Regulation 2, Rule 1: General Requirements.					

4. BIOLOGICAL RESOURCES. Would the project:				
	<i>Potentially Significant impacts</i>	<i>Significant Unless Mitigated</i>	<i>Less Than Significant impact</i>	<i>No Impact</i>
4.a. Have a significant adverse effect, either directly or through habitat modifications, on any species identified as a candidate, sensitive, or special status species in local or regional plans, policies, or regulations, or by the California Department of Fish and Wildlife or U.S. Fish and Wildlife Service?				X
<p>Discussion: The project site is disturbed and developed with an existing residential use. It is not located within any riparian/sensitive habitat areas and will not modify the habitat of any species identified as a candidate, sensitive, or special status species in local or regional plans, policies, or regulations, or by the California Department of Fish and Wildlife or U.S. Fish and Wildlife Service.</p> <p>Source: San Mateo County General Plan Sensitive Habitats and GIS Resource Maps.</p>				
4.b. Have a significant adverse effect on any riparian habitat or other sensitive natural community identified in local or regional plans, policies, and regulations or by the California Department of Fish and Wildlife or U.S. Fish and Wildlife Service?				X
<p>Discussion: Reference response to Section 4.a., above.</p> <p>Source: San Mateo County General Plan Sensitive Habitats and GIS Resource Maps.</p>				
4.c. Have a significant adverse effect on federally protected wetlands as defined by Section 404 of the Clean Water Act (including, but not limited to, marsh, vernal pool, coastal, etc.) through direct removal, filling, hydrological interruption, or other means?			X	
<p>Discussion: A Preliminary Delineation of Wetlands Report prepared by Coast Range Biological, LLC (Wetlands Report), dated December 2013, was submitted that showed the location of a wetland area, the Pillar Point Marsh, to be 125 feet southwest of the project site. The project site falls outside the minimum 100-foot buffer zone required by the County Local Coastal Program. No mitigation measures are required.</p> <p>Source: San Mateo County General Plan Sensitive Habitats and GIS Resource Maps, and Wetlands Report.</p>				

4.d. Interfere significantly with the movement of any native resident or migratory fish or wildlife species or with established native resident migratory wildlife corridors, or impede the use of native wildlife nursery sites?				X
<p>Discussion: Reference response to Section 4.a., above.</p> <p>Source: San Mateo County General Plan Sensitive Habitats and GIS Resource Maps.</p>				
4.e. Conflict with any local policies or ordinances protecting biological resources, such as a tree preservation policy or ordinance (including the County Heritage and Significant Tree Ordinances)?			X	
<p>Discussion: The proposed removal of two significant trees is not in conflict with the County Significant Tree Ordinance. A Tree Assessment Report (Arborist Report) from Jim Gillespie, Consultant Arborist, was submitted for the two Monterey cypress trees proposed for removal. Based on this report, one tree is required to be removed since it is located within the building envelope of the proposed addition. The removal of the other tree is recommended to allow more light and moisture to sustain the health of an existing Monterey cypress tree. The proposed landscaping shown on Sheet A-1.01 of Attachment A includes the plantings of four (4) new trees meeting County replacement requirements.</p> <p>Source: Project Plans, Field Observation and Arborist Report.</p>				
4.f. Conflict with the provisions of an adopted Habitat Conservation Plan, Natural Conservation Community Plan, other approved local, regional, or State habitat conservation plan?				X
<p>Discussion: Reference response to Section 4.a., above.</p> <p>Source: San Mateo County General Plan Sensitive Habitats and GIS Resource Maps.</p>				
4.g. Be located inside or within 200 feet of a marine or wildlife reserve?				X
<p>Discussion: N/A. The site is not located within a marine or wildlife reserve.</p> <p>Source: San Mateo County General Plan Sensitive Habitats and GIS Resource Maps.</p>				
4.h. Result in loss of oak woodlands or other non-timber woodlands?				X
<p>Discussion: Reference response to Section 4.e., above.</p> <p>Source: San Mateo County General Plan Sensitive Habitats and GIS Resource Maps.</p>				

5. CULTURAL RESOURCES. Would the project:				
	<i>Potentially Significant Impacts</i>	<i>Significant Unless Mitigated</i>	<i>Less Than Significant Impact</i>	<i>No Impact</i>
5.a. Cause a significant adverse change in the significance of a historical resource as defined in CEQA Section 15064.5?				X
<p>Discussion: N/A. The project site does not contain any historical resource. The residence is not considered historic.</p> <p>Source: Project Application/Plans and San Mateo County General Plan.</p>				
5.b. Cause a significant adverse change in the significance of an archaeological resource pursuant to CEQA Section 15064.5?				X
<p>Discussion: N/A. No excavation is proposed as part of the project.</p> <p>Source: Project Application/Plans and San Mateo County General Plan.</p>				
5.c. Directly or indirectly destroy a unique paleontological resource or site or unique geologic feature?				X
<p>Discussion: Reference response to Section 5.b., above.</p> <p>Source: Project Application/Plans and San Mateo County General Plan.</p>				
5.d. Disturb any human remains, including those interred outside of formal cemeteries?				X
<p>Discussion: Reference response to Section 5.b., above.</p> <p>Source: Project Application/Plans and San Mateo County General Plan.</p>				

6. GEOLOGY AND SOILS. Would the project:				
	<i>Potentially Significant Impacts</i>	<i>Significant Unless Mitigated</i>	<i>Less Than Significant Impact</i>	<i>No Impact</i>
6.a. Expose people or structures to potential significant adverse effects, including the risk of loss, injury, or death involving the following, or create a situation that results in:				

<p>i. Rupture of a known earthquake fault, as delineated on the most recent Alquist-Priolo Earthquake Fault Zoning Map issued by the State Geologist for the area or based on other significant evidence of a known fault?</p> <p><i>Note: Refer to Division of Mines and Geology Special Publication 42 and the County Geotechnical Hazards Synthesis Map.</i></p>		X		
<p>Discussion: The Geotechnical Section will review the proposal when an application for the required building permit is submitted to verify that there are no geotechnical issues.</p> <p>A Geotechnical Report prepared by Romig Engineers, Inc. (Geotechnical Report), dated September 12, 2014, was submitted that located the primary trace of the San Gregorio/Seal Cove Fault to be west of the project site. The report declares that there is no evidence to support the occurrence of potential ground surface rupture at the site relative to the fault traces. Although no fault trenching is required as a means to confirm this evaluation, the Geotechnical Report recommends the following mitigation measure:</p> <p>Mitigation Measure 1: Complete a design-level geotechnical investigation including subsurface exploration to address the geotechnical conditions at the site and to provide earthwork guidelines and foundation design criteria for the proposed remodeling and addition to the residence.</p> <p>Source: San Mateo County Geotechnical Hazards Synthesis Map, California Geological Survey - Alquist-Priolo Earthquake Fault Zones and Geotechnical Report.</p>				
<p>ii. Strong seismic ground shaking?</p>		X		
<p>Discussion: Reference response to Section 6.a., above.</p> <p>Source: San Mateo County Geotechnical Hazards Synthesis Map, California Geological Survey - Alquist-Priolo Earthquake Fault Zones and Geotechnical Report.</p>				
<p>iii. Seismic-related ground failure, including liquefaction and differential settling?</p>		X		
<p>Discussion: Reference response to Section 6.a., above.</p> <p>Source: San Mateo County Geotechnical Hazards Synthesis Map, California Geological Survey - Alquist-Priolo Earthquake Fault Zones and Geotechnical Report.</p>				
<p>iv. Landslides?</p>			X	
<p>Discussion: The project is not located in an area susceptible to landslides. The topography of the site is relatively flat.</p> <p>Source: State of California Seismic Hazard Zone Map/San Mateo County Landslide Susceptibility Map.</p>				

<p>v. Coastal cliff/bluff instability or erosion?</p> <p><i>Note to reader: This question is looking at instability under current conditions. Future, potential instability is looked at in Section 7 (Climate Change).</i></p>			X	
<p>Discussion: N/A. The site is not located on a cliff or bluff.</p> <p>Source: Project Plans/County GIS Resource Map and Geotechnical Report.</p>				
<p>6.b. Result in significant soil erosion or the loss of topsoil?</p>			X	
<p>Discussion: The project will not result in soil erosion or loss of topsoil.</p> <p>Source: Project Application/Plans.</p>				
<p>6.c. Be located on a geologic unit or soil that is unstable, or that would become unstable as a result of the project, and potentially result in on- or off-site landslide, lateral spreading, subsidence, severe erosion, liquefaction or collapse?</p>			X	
<p>Discussion: The site has not been identified to be made up of unstable soil. Reference response to Section 6.a.i. through 6.a.iv., above.</p> <p>Source: San Mateo County Geotechnical Hazards Synthesis Map, California Geological Survey - Alquist-Priolo Earthquake Fault Zones, State of California Seismic Hazard Zone Map/San Mateo County Landslide Susceptibility Map and Geotechnical Report.</p>				
<p>6.d. Be located on expansive soil, as noted in the 2010 California Building Code, creating significant risks to life or property?</p>			X	
<p>Discussion: The site has not been identified to be made up of expansive soil. Reference response to Section 6.a.i. through 6.a.iv., above.</p> <p>Source: San Mateo County Geotechnical Hazards Synthesis Map, California Geological Survey - Alquist-Priolo Earthquake Fault Zones, State of California Seismic Hazard Zone Map/San Mateo County Landslide Susceptibility Map and Geotechnical Report.</p>				
<p>6.e. Have soils incapable of adequately supporting the use of septic tanks or alternative wastewater disposal systems where sewers are not available for the disposal of wastewater?</p>				X
<p>Discussion: The project does not involve a septic system for wastewater disposal since the project area is already serviced by GSD.</p> <p>Source: Project Application/Plans and San Mateo County GIS Resource Maps.</p>				

7. CLIMATE CHANGE. Would the project:				
	<i>Potentially Significant Impacts</i>	<i>Significant Unless Mitigated</i>	<i>Less Than Significant Impact</i>	<i>No Impact</i>
7.a. Generate greenhouse gas (GHG) emissions (including methane), either directly or indirectly, that may have a significant impact on the environment?			X	
<p>Discussion: To ensure new development projects are compliant with the County's Energy Efficiency Climate Action Plan (EECAP), the County provides the EECAP Development Checklist. Planning staff has reviewed the proposal with the criteria of the checklist and found that there are no criteria that are applicable for the project. No mitigation measures required. Also, reference response to Section 3.a., above.</p> <p>Source: San Mateo County Energy Efficiency Climate Action Plan (EECAP) and BAAQMD Regulation 2, Rule 1: General Requirements.</p>				
7.b. Conflict with an applicable plan (including a local climate action plan), policy or regulation adopted for the purpose of reducing the emissions of greenhouse gases?				X
<p>Discussion: Reference response to Section 3.a., above.</p> <p>Source: BAAQMD Regulation 2, Rule 1: General Requirements.</p>				
7.c. Result in the loss of forestland or conversion of forestland to non-forest use, such that it would release significant amounts of GHG emissions, or significantly reduce GHG sequestering?				X
<p>Discussion: The project does not involve loss or conversion of forestland.</p> <p>Source: Project Application/Plans.</p>				
7.d. Expose new or existing structures and/or infrastructure (e.g., leach fields) to accelerated coastal cliff/bluff erosion due to rising sea levels?				X
<p>Discussion: The project site is not located on a cliff or bluff.</p> <p>Source: San Mateo County GIS Resource Maps.</p>				
7.e. Expose people or structures to a significant risk of loss, injury or death involving sea level rise?				X

<p>Discussion: The projected future sea level rise of 3.5 feet over the next 75 years will not expose people or structures to significant environmental impacts.</p> <p>Source: San Mateo County GIS Resource Maps and Tsunami Runup and Force Analysis Report prepared by GeoSoils, Inc. (Tsunami Report).</p>					
7.f.	Place structures within an anticipated 100-year flood hazard area as mapped on a Federal Flood Hazard Boundary or Flood Insurance Rate Map or other flood hazard delineation map?			X	
<p>Discussion: The project site is located in Flood Zone X designated as minimal risk areas outside the 1-percent and 0.2-percent-annual-chance floodplains.</p> <p>Source: FEMA Flood Insurance Rate Map.</p>					
7.g.	Place within an anticipated 100-year flood hazard area structures that would impede or redirect flood flows?			X	
<p>Discussion: Reference response to Section 7.f., above.</p> <p>Source: Flood Insurance Rate Map.</p>					

8. HAZARDS AND HAZARDOUS MATERIALS. Would the project:					
		<i>Potentially Significant Impacts</i>	<i>Significant Unless Mitigated</i>	<i>Less Than Significant Impact</i>	<i>No Impact</i>
8.a.	Create a significant hazard to the public or the environment through the routine transport, use, or disposal of hazardous materials (e.g., pesticides, herbicides, other toxic substances, or radioactive material)?				X
<p>Discussion: N/A. The project does not involve the transport, use or disposal of hazardous materials.</p> <p>Source: Project Application/Plans.</p>					
8.b.	Create a significant hazard to the public or the environment through reasonably foreseeable upset and accident conditions involving the release of hazardous materials into the environment?				X
<p>Discussion: Reference response to Section 8.a., above.</p> <p>Source: Project Application/Plans.</p>					

8.c. Emit hazardous emissions or handle hazardous or acutely hazardous materials, substances, or waste within one-quarter mile of an existing or proposed school?				X
<p>Discussion: Reference response to Section 8.a., above.</p> <p>Source: Project Application/Plans.</p>				
8.d. Be located on a site which is included on a list of hazardous materials sites compiled pursuant to Government Code Section 65962.5 and, as a result, would it create a significant hazard to the public or the environment?				X
<p>Discussion: The project parcel is not considered a hazardous material site, according to the latest Hazardous Waste and Substances Site List posted by the California Department of Toxic Substances Control (mandated by Government Code Section 65962.5).</p> <p>Source: California Department of Toxic Substances Control, Hazardous Waste and Substances Site List.</p>				
8.e. For a project located within an airport land use plan or, where such a plan has not been adopted, within 2 miles of a public airport or public use airport, result in a safety hazard for people residing or working in the project area?			X	
<p>Discussion: Based on the Airport Land Use Compatibility Plan, as adopted on October 9, 2014, the project site is located in Zone 7 - Airport Influence Area (AIA), where the aircraft accident level is considered to be low within this zone.</p> <p>Source: Project Application/Plans, San Mateo County GIS Resource Maps and HMB ALUCP.</p>				
8.f. For a project within the vicinity of a private airstrip, result in a safety hazard for people residing or working in the project area?			X	
<p>Discussion: Reference response to Section 8.e., above.</p> <p>Source: Project Application/Plans and San Mateo County GIS Resource Maps.</p>				
8.g. Impair implementation of or physically interfere with an adopted emergency response plan or emergency evacuation plan?				X

<p>Discussion: The project will not physically interfere with an adopted emergency plan. The project site is located in a developed coastal area with available access to emergency response agencies such as the Coastside Fire Protection District and the San Mateo County Sheriff's Department.</p> <p>Source: Project Application/Plans and San Mateo County GIS Resource Maps.</p>					
8.h.	Expose people or structures to a significant risk of loss, injury or death involving wildland fires, including where wildlands are adjacent to urbanized areas or where residences are intermixed with wildlands?				X
<p>Discussion: The project site is not located within a wildland area.</p> <p>Source: Project Application/Plans and San Mateo County GIS Resource Maps.</p>					
8.i.	Place housing within an existing 100-year flood hazard area as mapped on a Federal Flood Hazard Boundary or Flood Insurance Rate Map or other flood hazard delineation map?			X	
<p>Discussion: Reference response to Section 7.f., above.</p> <p>Source: FEMA Flood Insurance Rate Map.</p>					
8.j.	Place within an existing 100-year flood hazard area structures that would impede or redirect flood flows?			X	
<p>Discussion: Reference response to Section 7.f., above.</p> <p>Source: FEMA Flood Insurance Rate Map.</p>					
8.k.	Expose people or structures to a significant risk of loss, injury or death involving flooding, including flooding as a result of the failure of a levee or dam?			X	
<p>Discussion: Reference response to Section 7.f., above.</p> <p>Source: FEMA Flood Insurance Rate Map.</p>					
8.l.	Inundation by seiche, tsunami, or mudflow?			X	
<p>Discussion: The project site is located in a tsunami hazard zone, as identified in the San Mateo County General Plan Hazards Map. A Tsunami Runup and Force Analysis Report (Tsunami Report) prepared by GeoSoils, Inc., dated December 12, 2014, was submitted that indicated the project site to be safe from potential hazards due to the presence of the breakwater that dissipates wave forces caused by tsunamis.</p> <p>Source: San Mateo County General Plan Hazards Map and Tsunami Report.</p>					

9. HYDROLOGY AND WATER QUALITY. Would the project:				
	<i>Potentially Significant Impacts</i>	<i>Significant Unless Mitigated</i>	<i>Less Than Significant Impact</i>	<i>No Impact</i>
9.a. Violate any water quality standards or waste discharge requirements (consider water quality parameters such as temperature, dissolved oxygen, turbidity and other typical stormwater pollutants (e.g., heavy metals, pathogens, petroleum derivatives, synthetic organics, sediment, nutrients, oxygen-demanding substances, and trash))?			X	
<p>Discussion: The project, as proposed, would result in less than significant impacts in this area upon implementation of the proposed Erosion Control Plan and Best Management Practices (BMPs) shown on Sheets C-3 and C-3.1 on Attachment A.</p> <p>Source: Project Application/Plans.</p>				
9.b. Significantly deplete groundwater supplies or interfere significantly with groundwater recharge such that there would be a net deficit in aquifer volume or a lowering of the local groundwater table level (e.g., the production rate of pre-existing nearby wells would drop to a level which would not support existing land uses or planned uses for which permits have been granted)?				X
<p>Discussion: The existing residence does not involve direct use of groundwater as a domestic water source since the project site is located in a developed industrial zone already serviced by Coastside County Water District.</p> <p>Source: Project Application/Plans.</p>				
9.c. Significantly alter the existing drainage pattern of the site or area, including through the alteration of the course of a stream or river, in a manner that would result in significant erosion or siltation on- or off-site?				X
<p>Discussion: The project would not impact the drainage pattern of the area. Also, see response to Section 9.e., below.</p> <p>Source: Project Application/Plans.</p>				

9.d.	Significantly alter the existing drainage pattern of the site or area, including through the alteration of the course of a stream or river, or significantly increase the rate or amount of surface runoff in a manner that would result in flooding on- or off-site?			X	
<p>Discussion: The project would not impact the drainage pattern of the area. Also, see response to Section 9.e., below.</p> <p>Source: Project Application/Plans.</p>					
9.e.	Create or contribute runoff water that would exceed the capacity of existing or planned stormwater drainage systems or provide significant additional sources of polluted runoff?			X	
<p>Discussion: The project's impervious areas will increase to include new drainage facilities to address this accordingly. At the time of submittal for a building permit, the project will be subject to review for compliance with all County drainage policies and the County's Municipal Stormwater Regional Permit.</p> <p>Source: Project Application/Plans and San Mateo County Drainage Policy.</p>					
9.f.	Significantly degrade surface or ground-water water quality?				X
<p>Discussion: Reference response to Section 9.e., above.</p> <p>Source: Project Application/Plans.</p>					
9.g.	Result in increased impervious surfaces and associated increased runoff?				X
<p>Discussion: Reference response to Section 9.e., above.</p> <p>Source: Project Application/Plans.</p>					

10. LAND USE AND PLANNING. Would the project:				
	<i>Potentially Significant Impacts</i>	<i>Significant Unless Mitigated</i>	<i>Less Than Significant Impact</i>	<i>No Impact</i>
10.a.	Physically divide an established community?			X

<p>Discussion: N/A. The project involves the enlargement of an existing residential use at the site and will not divide an established community.</p> <p>Source: Project Application/Plans.</p>					
10.b.	Conflict with any applicable land use plan, policy or regulation of an agency with jurisdiction over the project (including, but not limited to, the general plan, specific plan, local coastal program, or zoning ordinance) adopted for the purpose of avoiding or mitigating an environmental effect?			X	
<p>Discussion: The project is subject to the approval of a Non-Conforming Use Permit, pursuant to Section 6134.6 of the San Mateo County Zoning Regulations. The project meets the required findings for the enlargement of the existing non-conforming residential use.</p> <p>Source: San Mateo County General Plan and San Mateo Zoning Regulations.</p>					
10.c.	Conflict with any applicable habitat conservation plan or natural community conservation plan?				X
<p>Discussion: N/A. The project site is not located within any habitat/conservation areas. Reference response to Section 4.a., above.</p> <p>Source: California Department of Fish and Wildlife, Habitat Conservation Planning.</p>					
10.d.	Result in the congregating of more than 50 people on a regular basis?				X
<p>Discussion: The project does not involve the congregation of more than 50 people since the existing use will remain single-family residential.</p> <p>Source: Project Application/Plans.</p>					
10.e.	Result in the introduction of activities not currently found within the community?			X	
<p>Discussion: The proposed project would not result in the introduction of new activities at the site. Single-family residential uses are established within the subject community.</p> <p>Source: Project Application/Plans.</p>					
10.f.	Serve to encourage off-site development of presently undeveloped areas or increase development intensity of already developed areas (examples include the introduction of new or expanded public utilities, new industry, commercial facilities or recreation activities)?				X

Discussion: The project does not encourage off-site development, as the proposed improvements would only serve to enlarge the current use of the site.				
Source: Project Plans and San Mateo County GIS Resource Maps.				
10.g. Create a significant new demand for housing?				X
Discussion: N/A. Reference response to Section 10.f., above.				
Source: Project Plans and San Mateo County GIS Resource Maps.				

11. MINERAL RESOURCES. Would the project:				
	<i>Potentially Significant Impacts</i>	<i>Significant Unless Mitigated</i>	<i>Less Than Significant Impact</i>	<i>No Impact</i>
11.a. Result in the loss of availability of a known mineral resource that would be of value to the region or the residents of the State?				X
Discussion: The project site is not located in an area known for mineral resources nor does the project involve mineral extraction.				
Source: Project Plans and San Mateo County GIS Resource Maps.				
11.b. Result in the loss of availability of a locally important mineral resource recovery site delineated on a local general plan, specific plan or other land use plan?				X
Discussion: Reference response to Section 11.a., above.				
Source: Project Plans and San Mateo County GIS Resource Maps.				

12. NOISE. Would the project result in:				
	<i>Potentially Significant Impacts</i>	<i>Significant Unless Mitigated</i>	<i>Less Than Significant Impact</i>	<i>No Impact</i>
12.a. Exposure of persons to or generation of noise levels in excess of standards established in the local general plan or noise ordinance, or applicable standards of other agencies?			X	

<p>Discussion: While this project will not generate noise levels in excess of appropriate levels once implemented, during construction activities, increased noise levels may occur. However, noise sources associated with demolition, construction or grading of any real property are exempt from the County Noise Ordinance provided these activities occur during designated timeframes.</p> <p>Source: Project Application/Plans and San Mateo County Noise Ordinance.</p>					
12.b.	Exposure of persons to or generation of excessive ground-borne vibration or ground-borne noise levels?			X	
<p>Discussion: Reference response to Section 12.a., above.</p> <p>Source: Project Application/Plans and San Mateo County Noise Ordinance.</p>					
12.c.	A significant permanent increase in ambient noise levels in the project vicinity above levels existing without the project?				X
<p>Discussion: Reference response to Section 12.a., above.</p> <p>Source: Project Application/Plans and San Mateo County Noise Ordinance.</p>					
12.d.	A significant temporary or periodic increase in ambient noise levels in the project vicinity above levels existing without the project?			X	
<p>Discussion: Reference response to Section 12.a., above.</p> <p>Source: Project Application/Plans and San Mateo County Noise Ordinance.</p>					
12.e.	For a project located within an airport land use plan or, where such a plan has not been adopted, within 2 miles of a public airport or public use airport, exposure to people residing or working in the project area to excessive noise levels?			X	
<p>Discussion: N/A. The project site is located outside the Community Noise Equivalent Level (CNEL) airport noise exposure contours and is therefore not exposed to significant levels of aircraft noise.</p> <p>Source: Project Application/Plans, San Mateo County Noise Ordinance and Airport Land Use Compatibility Plan (ALUCP).</p>					
12.f.	For a project within the vicinity of a private airstrip, exposure to people residing or working in the project area to excessive noise levels?			X	

Discussion: Reference response to Section 12.e., above.

Source: Project Application/Plans, San Mateo County Noise Ordinance and Airport Land Use Compatibility Plan (ALUCP).

13. POPULATION AND HOUSING. Would the project:				
	<i>Potentially Significant Impacts</i>	<i>Significant Unless Mitigated</i>	<i>Less Than Significant Impact</i>	<i>No Impact</i>
13.a. Induce significant population growth in an area, either directly (for example, by proposing new homes and businesses) or indirectly (for example, through extension of roads or other infrastructure)?				X
<p>Discussion: Reference response to Section 10.f., above.</p> <p>Source: Project Application/Plans.</p>				
13.b. Displace existing housing (including low- or moderate-income housing), in an area that is substantially deficient in housing, necessitating the construction of replacement housing elsewhere?				X
<p>Discussion: The project does not displace housing but enlarges an existing single-family residential use at the site.</p> <p>Source: Project Application/Plans.</p>				

14. PUBLIC SERVICES. Would the project result in significant adverse physical impacts associated with the provision of new or physically altered government facilities, the need for new or physically altered governmental facilities, the construction of which could cause significant environmental impacts, in order to maintain acceptable service ratios, response times or other performance objectives for any of the public services:				
	<i>Potentially Significant Impacts</i>	<i>Significant Unless Mitigated</i>	<i>Less Than Significant Impact</i>	<i>No Impact</i>
14.a. Fire protection?				X
14.b. Police protection?				X
14.c. Schools?				X
14.d. Parks?				X

14.e. Other public facilities or utilities (e.g., hospitals, or electrical/natural gas supply systems)?				X
<p>Discussion: The level of public services will not be significantly affected by the enlargement of the existing single-family residence in the neighborhood.</p> <p>Source: Project Application/Plans.</p>				

15. RECREATION. Would the project:				
	<i>Potentially Significant Impacts</i>	<i>Significant Unless Mitigated</i>	<i>Less Than Significant Impact</i>	<i>No Impact</i>
15.a. Increase the use of existing neighborhood or regional parks or other recreational facilities such that significant physical deterioration of the facility would occur or be accelerated?				X
<p>Discussion: The project will not generate an increase in the use of existing recreational facilities.</p> <p>Source: Project Application/Plans.</p>				
15.b. Include recreational facilities or require the construction or expansion of recreational facilities which might have an adverse physical effect on the environment?				X
<p>Discussion: New recreational facilities will not be required by this project.</p> <p>Source: Project Application/Plans.</p>				

16. TRANSPORTATION/TRAFFIC. Would the project:				
	<i>Potentially Significant Impacts</i>	<i>Significant Unless Mitigated</i>	<i>Less Than Significant Impact</i>	<i>No Impact</i>
16.a. Conflict with an applicable plan, ordinance or policy establishing measures of effectiveness for the performance of the circulation system, taking into account all modes of transportation including mass transit and non-motorized travel and relevant components of the circulation system, including, but not limited to, intersections, streets, highways and			X	

freeways, pedestrian and bicycle paths, and mass transit?				
<p>Discussion: The proposed addition to the existing residence would not result in noticeable changes in either vehicular or pedestrian traffic or volumes.</p> <p>Source: Project Plans and Field Observation.</p>				
16.b. Conflict with an applicable congestion management program, including, but not limited to, level of service standards and travel demand measures, or other standards established by the County congestion management agency for designated roads or highways?			X	
<p>Discussion: Reference response to Section 16.a., above.</p> <p>Source: Project Plans and Field Observation.</p>				
16.c. Result in a change in air traffic patterns, including either an increase in traffic levels or a change in location that results in significant safety risks?				X
<p>Discussion: N/A. The project will not result in a change in air traffic patterns.</p> <p>Source: Project Application/Plans and San Mateo County GIS Resource Maps.</p>				
16.d. Significantly increase hazards to a design feature (e.g., sharp curves or dangerous intersections) or incompatible uses (e.g., farm equipment)?			X	
<p>Discussion: No changes are proposed on any public right-of-way.</p> <p>Source: Project Plans and Field Observation.</p>				
16.e. Result in inadequate emergency access?			X	
<p>Discussion: The project will not impact emergency access to the site.</p> <p>Source: Project Plans and Field Observation.</p>				
16.f. Conflict with adopted policies, plans, or programs regarding public transit, bicycle, or pedestrian facilities, or otherwise decrease the performance or safety of such facilities?			X	
<p>Discussion: Reference response to Section 16.a., above.</p> <p>Source: Project Plans and Field Observation.</p>				

16.g.	Cause noticeable increase in pedestrian traffic or a change in pedestrian patterns?			X	
Discussion: Reference response to Section 16.a., above.					
Source: Project Plans and Field Observation.					
16.h.	Result in inadequate parking capacity?			X	
Discussion: The project complies with the County's Parking Regulations, as it includes two on-site covered parking spaces.					
Source: Project Plans and Field Observation.					

17. UTILITIES AND SERVICE SYSTEMS. Would the project:					
		<i>Potentially Significant Impacts</i>	<i>Significant Unless Mitigated</i>	<i>Less Than Significant Impact</i>	<i>No Impact</i>
17.a.	Exceed wastewater treatment requirements of the applicable Regional Water Quality Control Board?			X	
Discussion: The project site is already serviced by a sewer/water provider. The proposed project would not adversely affect the capacity of any public utilities. Any use of public facilities and other public utilities would be minimal associated with this standard single-family dwelling and associated residents.					
Source: Project Application/Plans.					
17.b.	Require or result in the construction of new water or wastewater treatment facilities or expansion of existing facilities, the construction of which could cause significant environmental effects?			X	
Discussion: Reference response to Section 17.a., above.					
Source: Project Application/Plans.					
17.c.	Require or result in the construction of new stormwater drainage facilities or expansion of existing facilities, the construction of which could cause significant environmental effects?				X
Discussion: Expanded drainage facilities would minimize the impacts of runoff to off-site areas.					
Source: Project Application/Plans.					

17.d. Have sufficient water supplies available to serve the project from existing entitlements and resources, or are new or expanded entitlements needed?				X
<p>Discussion: Reference response to Section 17.a., above. Source: Project Application/Plans.</p>				
17.e. Result in a determination by the wastewater treatment provider which serves or may serve the project that it has adequate capacity to serve the project's projected demand in addition to the provider's existing commitments?				X
<p>Discussion: Reference response to Section 17.a., above. Source: Project Application/Plans.</p>				
17.f. Be served by a landfill with insufficient permitted capacity to accommodate the project's needs?				X
<p>Discussion: The project site is located in a developed industrial area already adequately serviced by a solid waste disposal provider. Source: Project Application/Plans.</p>				
17.g. Comply with Federal, State, and local statutes and regulations related to solid waste?				X
<p>Discussion: Reference response to Section 17.f., above. Source: Project Application/Plans.</p>				
17.h. Be sited, oriented, and/or designed to minimize energy consumption, including transportation energy; incorporate water conservation and solid waste reduction measures; and incorporate solar or other alternative energy sources?			X	
<p>Discussion: Standard energy savings, practices and measures can be applied to this project. Source: Project Application/Plans.</p>				

17.i. Generate any demands that will cause a public facility or utility to reach or exceed its capacity?			X	
--	--	--	---	--

Discussion: Reference response to Section 17.a., above.

Source: Project Application/Plans.

18. MANDATORY FINDINGS OF SIGNIFICANCE.

	<i>Potentially Significant Impacts</i>	<i>Significant Unless Mitigated</i>	<i>Less Than Significant Impact</i>	<i>No Impact</i>
18.a. Does the project have the potential to degrade the quality of the environment, significantly reduce the habitat of a fish or wildlife species, cause a fish or wildlife population to drop below self-sustaining levels, threaten to eliminate a plant or animal community, reduce the number or restrict the range of a rare or endangered plant or animal or eliminate important examples of the major periods of California history or prehistory?			X	

Discussion: Reference response to Section 4.a., above.

Source: San Mateo County General Plan Sensitive Habitats Map.

18.b. Does the project have impacts that are individually limited, but cumulatively considerable? ("Cumulatively considerable" means that the incremental effects of a project are considerable when viewed in connection with the effects of past projects, the effects of other current projects, and the effects of probable future projects.)			X	
---	--	--	---	--

Discussion: No cumulative effects are associated with this project.

Source: Project Application/Plans.

18.c. Does the project have environmental effects which will cause significant adverse effects on human beings, either directly or indirectly?			X	
--	--	--	---	--

Discussion: No environmental effects from the project will either directly or indirectly cause adverse effects on human beings.

Source: Project Application/Plans.

RESPONSIBLE AGENCIES. Check what agency has permit authority or other approval for the project.

AGENCY	YES	NO	TYPE OF APPROVAL
U.S. Army Corps of Engineers (CE)		X	
State Water Resources Control Board		X	
Regional Water Quality Control Board		X	
State Department of Public Health		X	
San Francisco Bay Conservation and Development Commission (BCDC)		X	
U.S. Environmental Protection Agency (EPA)		X	
County Airport Land Use Commission (ALUC)		X	
CalTrans		X	
Bay Area Air Quality Management District		X	
U.S. Fish and Wildlife Service		X	
Coastal Commission		X	
City		X	
Sewer/Water District:		X	
Other:			

MITIGATION MEASURE		
	<u>Yes</u>	<u>No</u>
Mitigation measure has been proposed in project application.	X	
Other mitigation measures are needed.		X
<p>The following measures are included in the project plans or proposals pursuant to Section 15070(b)(1) of the State CEQA Guidelines:</p> <p>Mitigation Measure 1: Complete a design-level geotechnical investigation including subsurface exploration to address the geotechnical conditions at the site and to provide earthwork guidelines and foundation design criteria for the proposed remodeling and addition to the residence.</p>		

DETERMINATION (to be completed by the Lead Agency).

On the basis of this initial evaluation:

I find the proposed project COULD NOT have a significant effect on the environment, and a NEGATIVE DECLARATION will be prepared by the Planning Department.

I find that although the proposed project could have a significant effect on the environment, there WILL NOT be a significant effect in this case because of the mitigation measure in the discussion that has been included as part of the proposed project. A NEGATIVE DECLARATION will be prepared.

I find that the proposed project MAY have a significant effect on the environment, and an ENVIRONMENTAL IMPACT REPORT is required.

(Signature)
Dennis Aguirre, Planner III
Name, Title

January 21, 2015
Date

ATTACHMENTS:

- A. Project Plans
- B. Geotechnical Report prepared on September 12, 2014 by Romig Engineers, Inc.
- C. Tsunami Runup and Force Analysis prepared on December 12, 2014 by GeoSoils, Inc.
- D. Preliminary Delineation of Wetlands prepared on December 2013 by Coast Range Biological, LLC
- E. Review Letter prepared on April 17, 2014 by Jim Gillespie, Consulting Arborist
- F. CDRC Decision Letter dated November 24, 2014

DPA:pac – DPAZ0094_WPH.DOCX
Initial Study Checklist 10.17.2013.docx

MPCN 043314
PLANNING PERMIT
REZA MALEK
115 WEST POINT AVENUE, CA 94019
MPCN 043314

MPCN 043314
PLANNING PERMIT
REZA MALEK
115 WEST POINT AVENUE, CA 94019
MPCN 043314

SYMBOLS

Table with 3 columns: Symbol, Abbreviation, and Description. Symbols include lines, arrows, and various geometric shapes.

ABBREVIATIONS

Table with 3 columns: Abbreviation, Description, and Notes. Abbreviations include ACT, RFL, INT, etc.

GENERAL NOTES

- 1. ALL ELECTRICAL WORK SHALL BE DONE IN ACCORDANCE WITH THE CALIFORNIA ELECTRICAL CODE (CEC) AND THE NATIONAL ELECTRICAL CODE (NEC).
2. ALL ELECTRICAL WORK SHALL BE DONE IN ACCORDANCE WITH THE LATEST EDITIONS OF THE NATIONAL ELECTRICAL CODE (NEC) AND THE CALIFORNIA ELECTRICAL CODE (CEC).

GENERAL ELECTRICAL NOTES

- 1. ALL ELECTRICAL WORK SHALL BE DONE IN ACCORDANCE WITH THE CALIFORNIA ELECTRICAL CODE (CEC) AND THE NATIONAL ELECTRICAL CODE (NEC).
2. ALL ELECTRICAL WORK SHALL BE DONE IN ACCORDANCE WITH THE LATEST EDITIONS OF THE NATIONAL ELECTRICAL CODE (NEC) AND THE CALIFORNIA ELECTRICAL CODE (CEC).

GENERAL MECHANICAL NOTES

- 1. ALL MECHANICAL WORK SHALL BE DONE IN ACCORDANCE WITH THE CALIFORNIA MECHANICAL CODE (CMC) AND THE NATIONAL MECHANICAL CODE (NMC).
2. ALL MECHANICAL WORK SHALL BE DONE IN ACCORDANCE WITH THE LATEST EDITIONS OF THE NATIONAL MECHANICAL CODE (NMC) AND THE CALIFORNIA MECHANICAL CODE (CMC).

PROPOSED EXISTING AREA TAKEOFF



SCOPE OF WORK
THE SCOPE OF WORK FOR THIS PROJECT IS TO PROVIDE A COMPLETE ELECTRICAL AND MECHANICAL DESIGN FOR THE PROPOSED BUILDING...

PROJECT DIRECTORY
OWNER: WEST POINT AVENUE
ARCHITECT: REZA MALEK
PLANNING PERMIT: MPCN 043314

DRAWING INDEX
DRAWING NO. 47-3
DATE: 08/15/2018
DRAWN BY: REZA MALEK

PROJECT DATA
REGULATIONS: CALIFORNIA ELECTRICAL CODE, CALIFORNIA MECHANICAL CODE
APPLICABLE CODES: 2017 CALIFORNIA ELECTRICAL CODE, 2017 CALIFORNIA MECHANICAL CODE

ADDITIONAL NOTES
REFER TO DRAWING SET FOR COMPLETE ELECTRICAL AND MECHANICAL DESIGN.

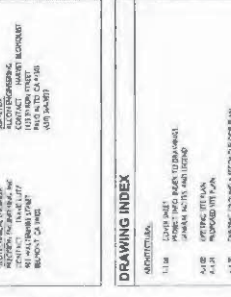
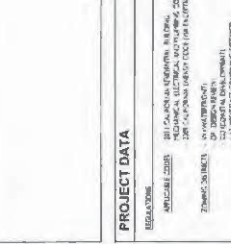

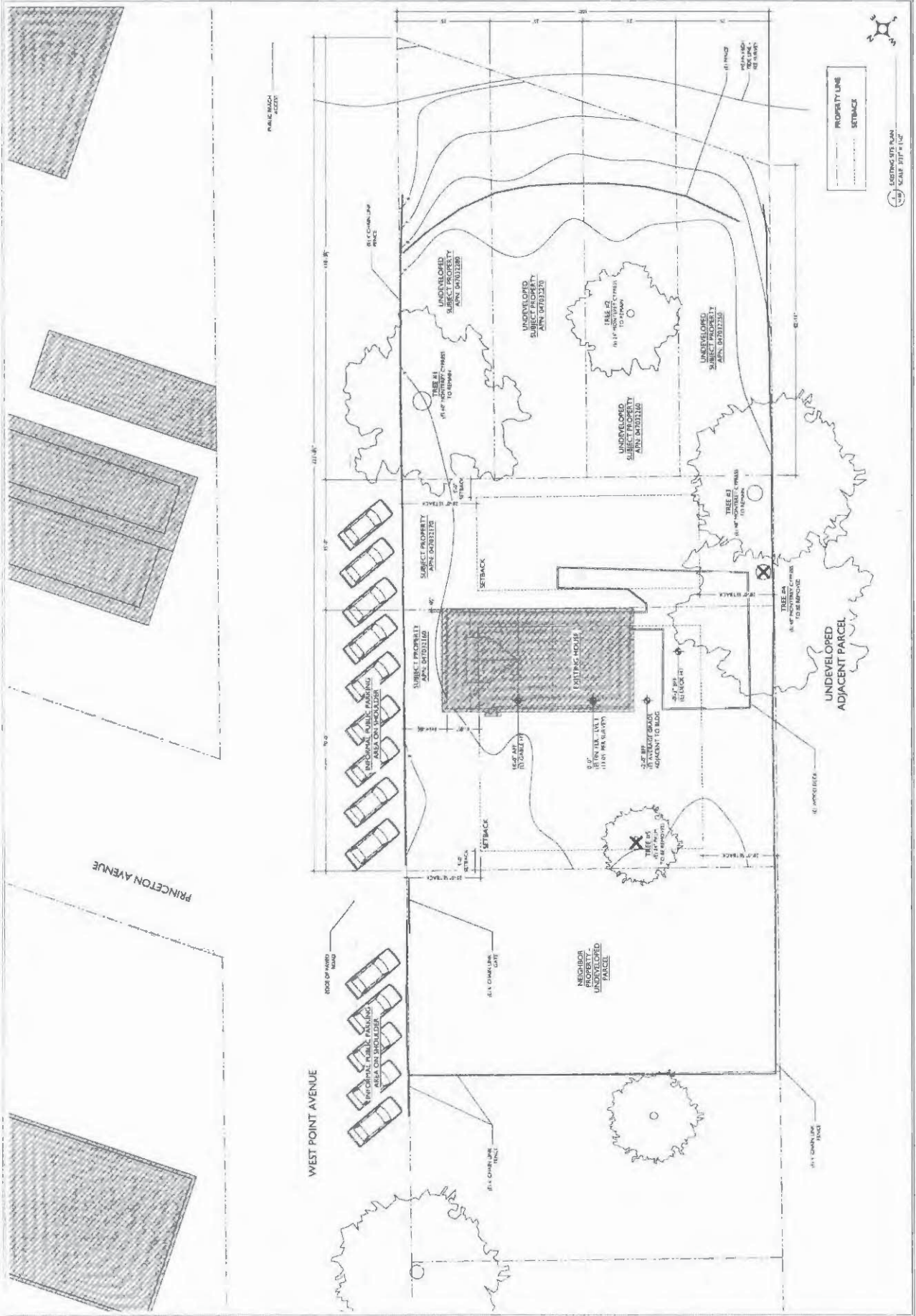



01	02/21/14	PLANNING PERMIT
----	----------	-----------------

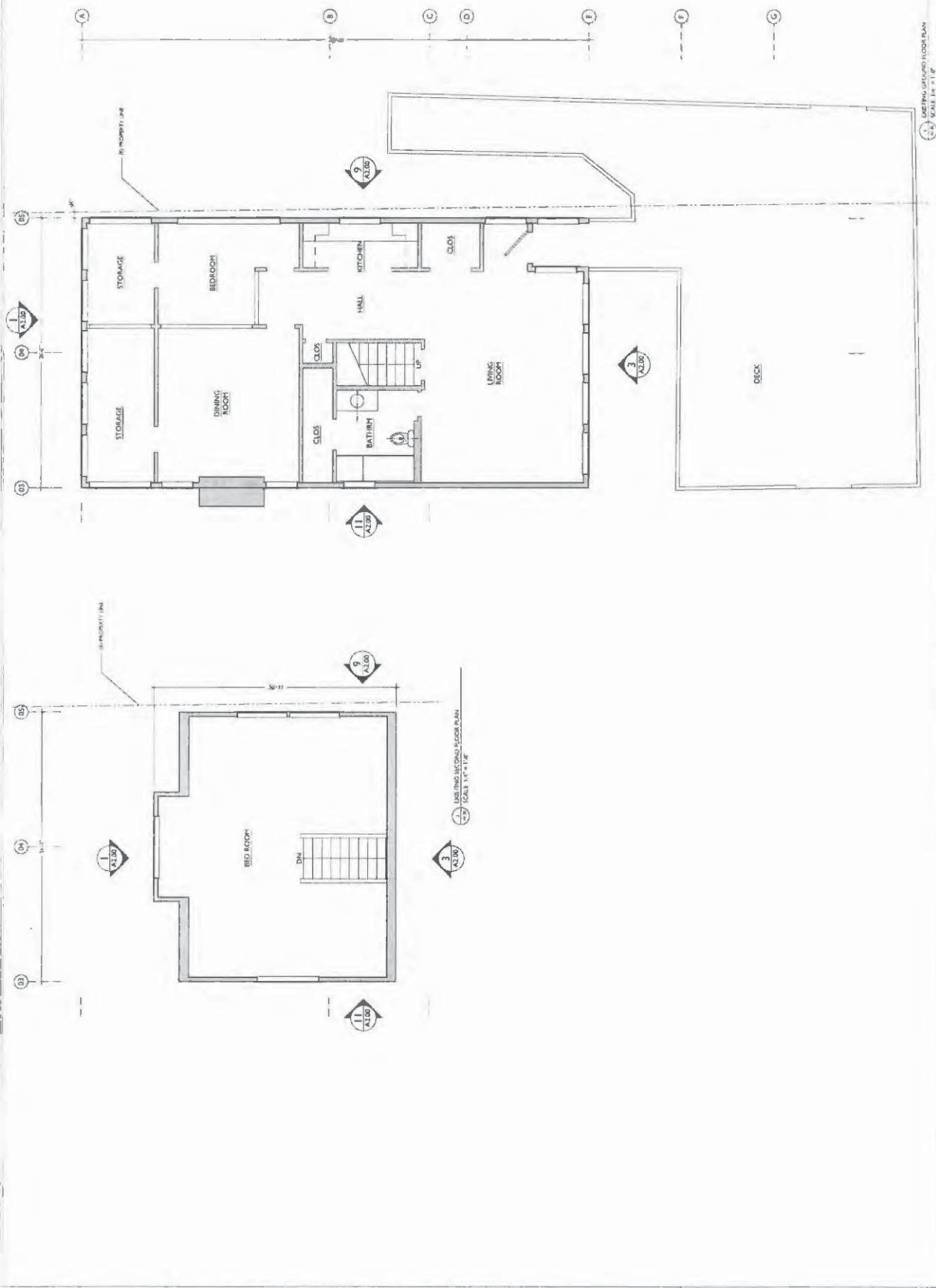



PCOFT ARCHITECTS
5445 SAN FRANCISCO CA 94103
415.319.2588
k@pcoft.com
pcoft.com



REZA MALEK
115 WEST POINT AVENUE
SAN FRANCISCO, CA 94115
APR 04/2018

01	02/18	PLANNING PERMIT
----	-------	-----------------

WEST POINT AVENUE
PLANNING SET
PROPOSED FIRST FLOOR PLAN

A-1.21

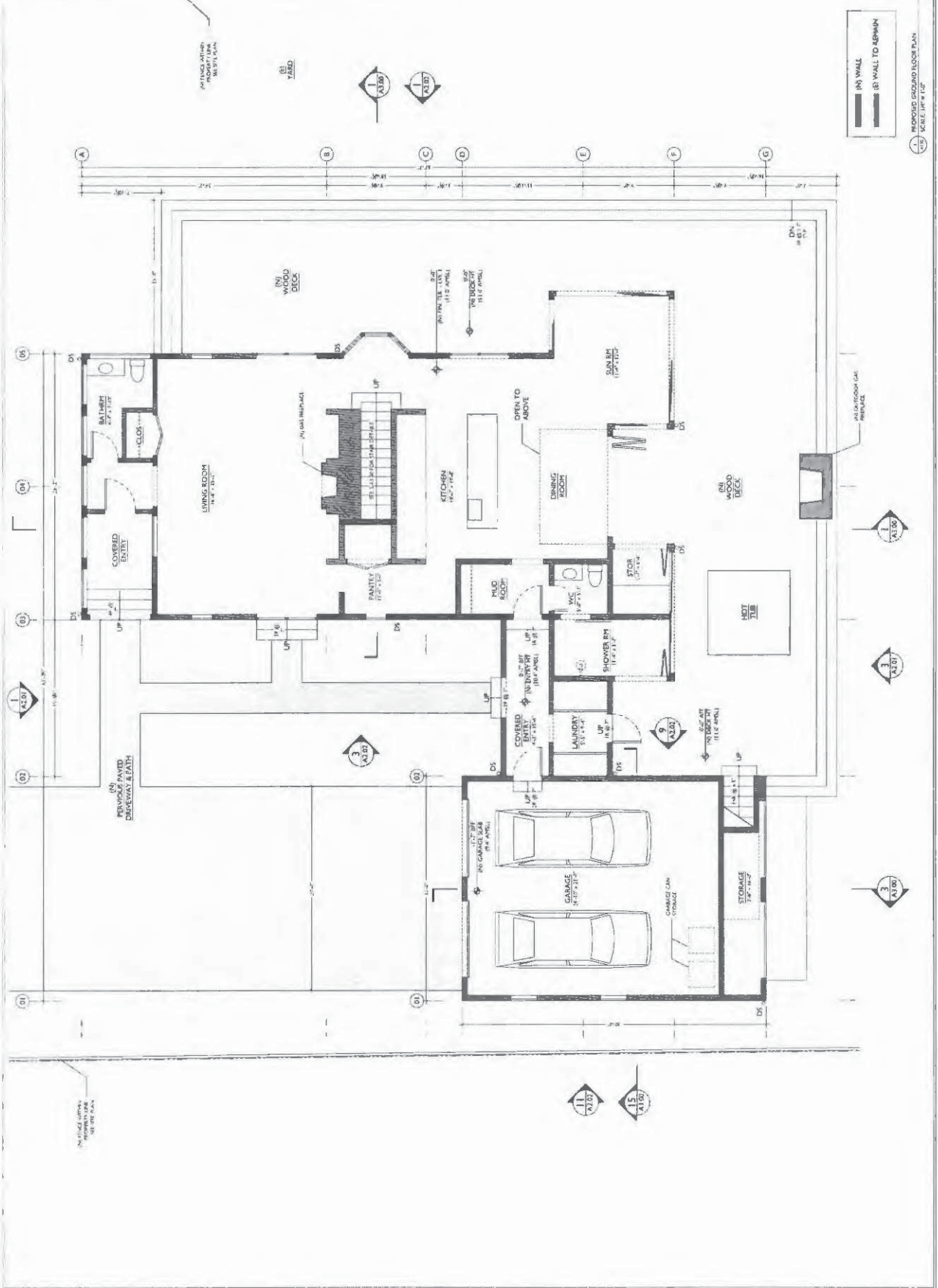

— (M) WALL
- - - (M) WALL TO REMOVE

PROPOSED GROUND FLOOR PLAN
SCALE: 1/8" = 1'-0"



01/12/14	PLANNING PERMIT
----------	-----------------

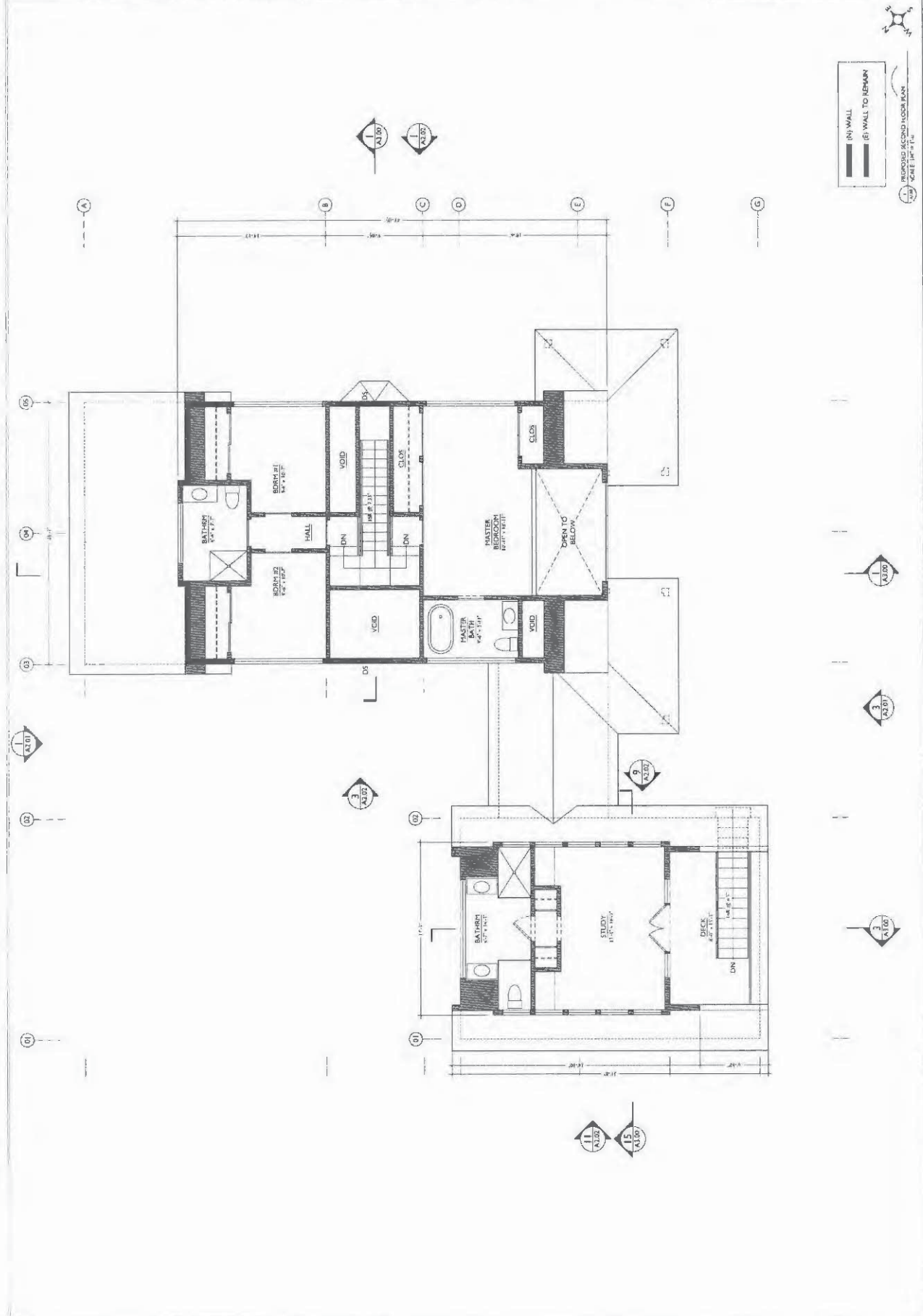

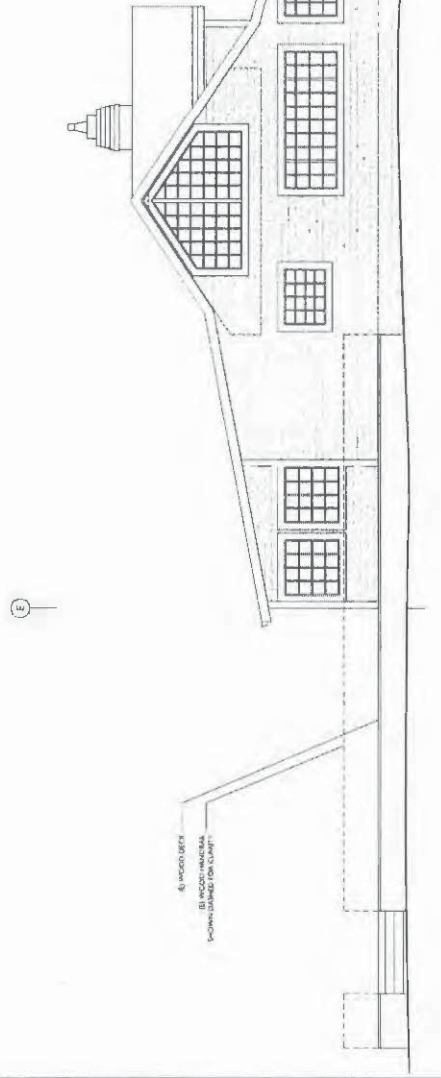
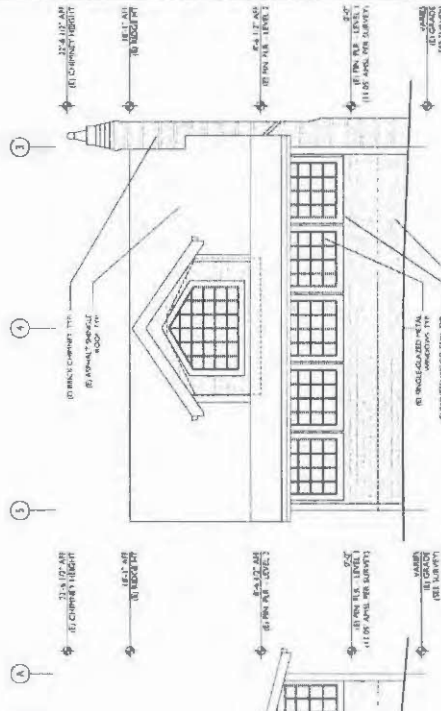
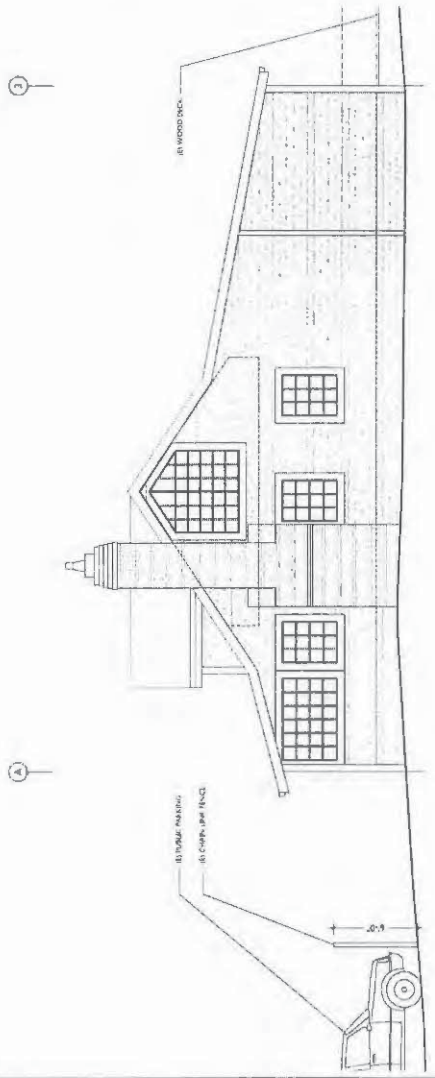
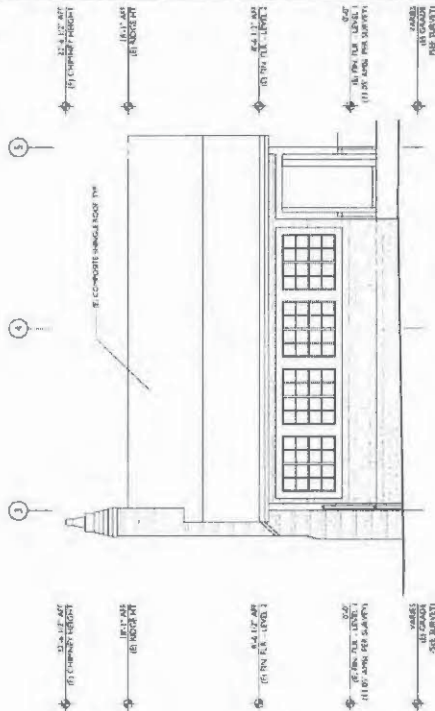

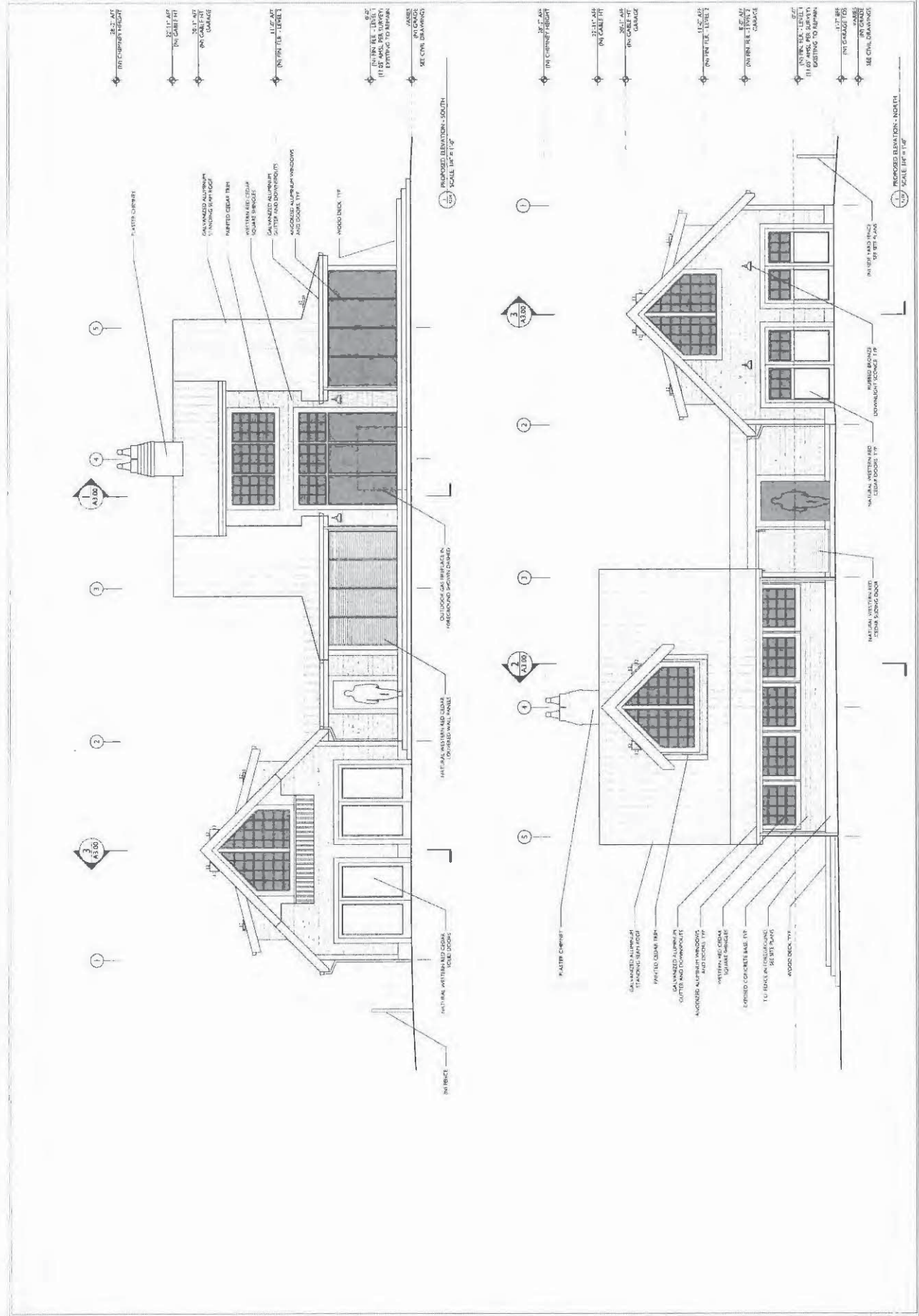

28.2' MAX
FIN COMPLETION HEIGHT

28.2' MAX
FIN COMPLETION HEIGHT

28.2' MAX
FIN COMPLETION HEIGHT

28.2' MAX
FIN COMPLETION HEIGHT

28.2' MAX
FIN COMPLETION HEIGHT

28.2' MAX
FIN COMPLETION HEIGHT

28.2' MAX
FIN COMPLETION HEIGHT

28.2' MAX
FIN COMPLETION HEIGHT

28.2' MAX
FIN COMPLETION HEIGHT

28.2' MAX
FIN COMPLETION HEIGHT

1. PROPOSED ELEVATION - SOUTH
SCALE: 1/4" = 1'-0"

1. PROPOSED ELEVATION - NORTH
SCALE: 1/4" = 1'-0"

1
A3.00

3
A3.00

2
A3.00

2
A3.00

1
A3.00

1
A3.00

3
A3.00

2
A3.00

1
A3.00

2
A3.00

1
A3.00

3
A3.00

PAINTED CEDAR TRIM

GALVANIZED ALUMINUM
1" FINISHING NAIL FOOT

PAINTED CEDAR TRIM

WESTERN RED CEDAR
SQUARE BRIDGE

GALVANIZED ALUMINUM
SILLER AND DOWNROCK
AND DOOR TY

WOOD SHOE, TYP

OUTDOOR GAS FIREPLACE IN
BACKGROUND POINT CHASE

PAINTED WESTERN RED CEDAR
DOUBLED WALL PANEL

PAINTED WESTERN RED CEDAR
TILE DOORS

BRICK

PAINTED CEDAR TRIM
FINISHING NAIL FOOT

GALVANIZED ALUMINUM
GUTTER AND DOWNROCK

GALVANIZED ALUMINUM
SILLER AND DOWNROCK

WESTERN RED CEDAR
SQUARE BRIDGE

WOOD SHOE, TYP

WOOD SHOE, TYP

PAINTED CEDAR TRIM
FINISHING NAIL FOOT

GALVANIZED ALUMINUM
GUTTER AND DOWNROCK

GALVANIZED ALUMINUM
SILLER AND DOWNROCK

WESTERN RED CEDAR
SQUARE BRIDGE

WOOD SHOE, TYP

WOOD SHOE, TYP

PAINTED CEDAR TRIM
FINISHING NAIL FOOT

GALVANIZED ALUMINUM
GUTTER AND DOWNROCK

GALVANIZED ALUMINUM
SILLER AND DOWNROCK

WESTERN RED CEDAR
SQUARE BRIDGE

WOOD SHOE, TYP

WOOD SHOE, TYP

PAINTED WESTERN RED CEDAR
DOUBLED WALL PANEL

PAINTED WESTERN RED CEDAR
TILE DOORS

BRICK

PAINTED WESTERN RED CEDAR
DOWNROCK SQUARE TYP

PAINTED WESTERN RED CEDAR
DOWNROCK SQUARE TYP

PAINTED WESTERN RED CEDAR
DOWNROCK SQUARE TYP

PAINTED WESTERN RED CEDAR
DOWNROCK SQUARE TYP

PAINTED WESTERN RED CEDAR
DOWNROCK SQUARE TYP

PAINTED WESTERN RED CEDAR
DOWNROCK SQUARE TYP

PAINTED WESTERN RED CEDAR
DOWNROCK SQUARE TYP

PAINTED WESTERN RED CEDAR
DOWNROCK SQUARE TYP

PAINTED WESTERN RED CEDAR
DOWNROCK SQUARE TYP

PAINTED WESTERN RED CEDAR
DOWNROCK SQUARE TYP

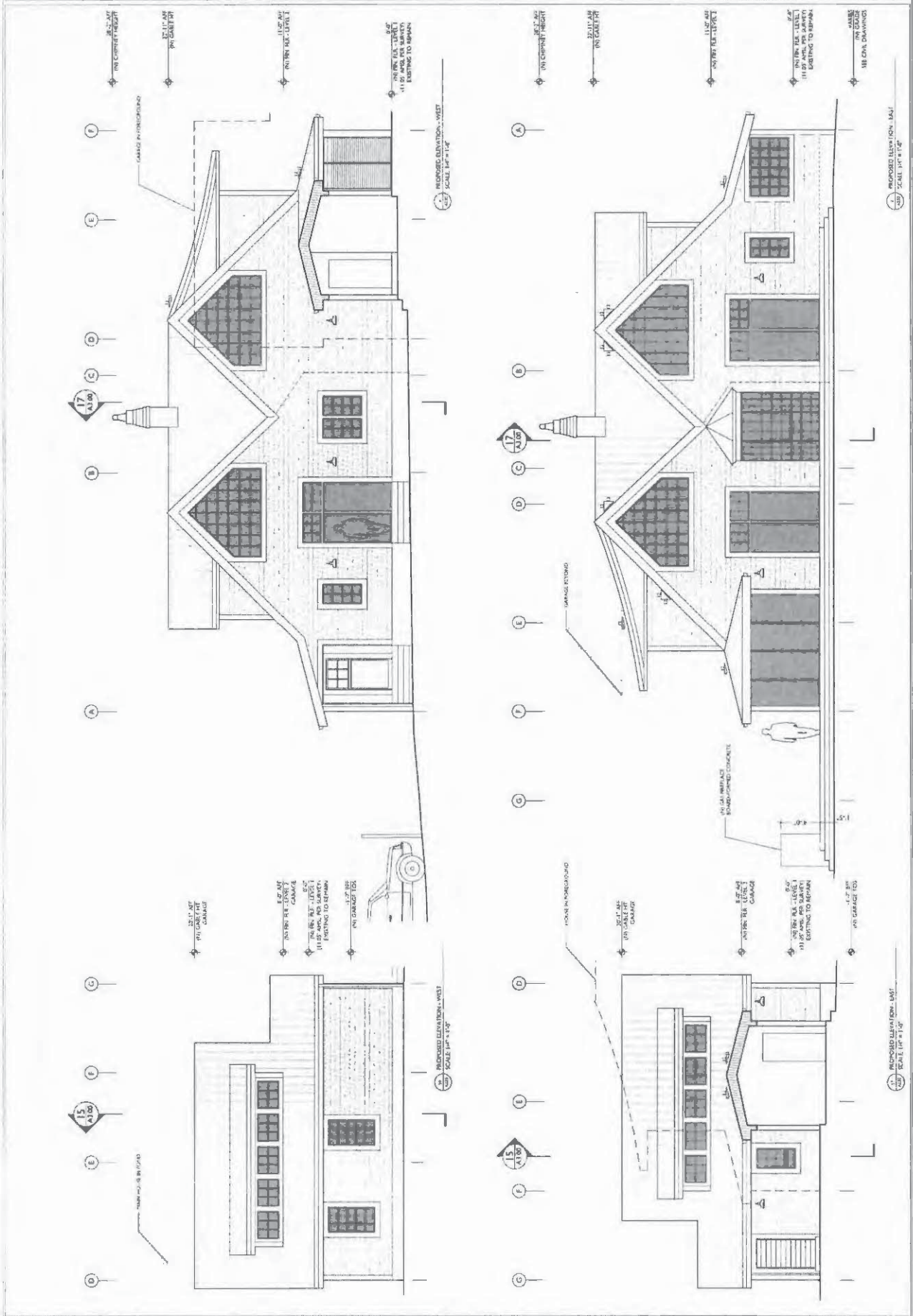

17 ALSO

17 ALSO

15 ALSO

17 ALSO

17 ALSO

15 ALSO

PROPOSED ELEVATION - EAST
SCALE 1/4" = 1'-0"

PROPOSED ELEVATION - WEST
SCALE 1/4" = 1'-0"

11'-0" GARAGE FLOOR
FINISH GARAGE FLOOR
FINISH GARAGE FLOOR

11'-0" GARAGE FLOOR
FINISH GARAGE FLOOR
FINISH GARAGE FLOOR

11'-0" GARAGE FLOOR
FINISH GARAGE FLOOR
FINISH GARAGE FLOOR

11'-0" GARAGE FLOOR
FINISH GARAGE FLOOR
FINISH GARAGE FLOOR

11'-0" GARAGE FLOOR
FINISH GARAGE FLOOR
FINISH GARAGE FLOOR

11'-0" GARAGE FLOOR
FINISH GARAGE FLOOR
FINISH GARAGE FLOOR

11'-0" GARAGE FLOOR
FINISH GARAGE FLOOR
FINISH GARAGE FLOOR

11'-0" GARAGE FLOOR
FINISH GARAGE FLOOR
FINISH GARAGE FLOOR

11'-0" GARAGE FLOOR
FINISH GARAGE FLOOR
FINISH GARAGE FLOOR

11'-0" GARAGE FLOOR
FINISH GARAGE FLOOR
FINISH GARAGE FLOOR

PROPOSED ELEVATION - WEST
SCALE 1/4" = 1'-0"

11'-0" GARAGE FLOOR
FINISH GARAGE FLOOR
FINISH GARAGE FLOOR

PROPOSED ELEVATION - EAST
SCALE 1/4" = 1'-0"



15
A3.00

D E F G

3
A3.00

1

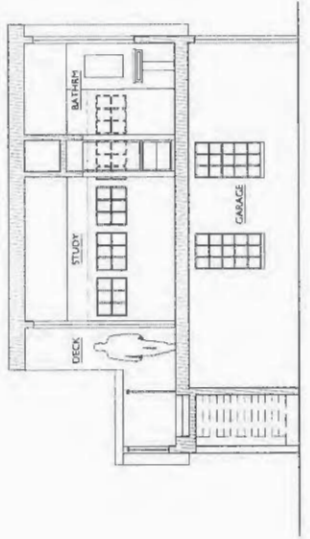

LONG SECTION - GARAGE ADDITION
SCALE 1/4" = 1'-0"

1'-0" GARAGE FLOOR
1'-0" GARAGE FLOOR
1'-0" GARAGE FLOOR
1'-0" GARAGE FLOOR

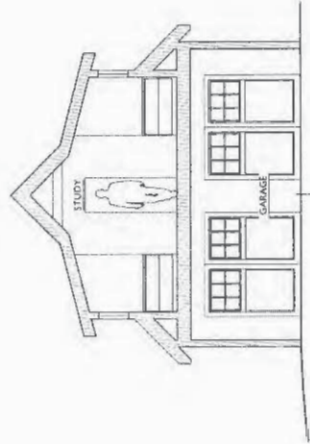

CROSS SECTION - GARAGE ADDITION
SCALE 1/4" = 1'-0"

15
A3.00

D E F G

3
A3.00

1

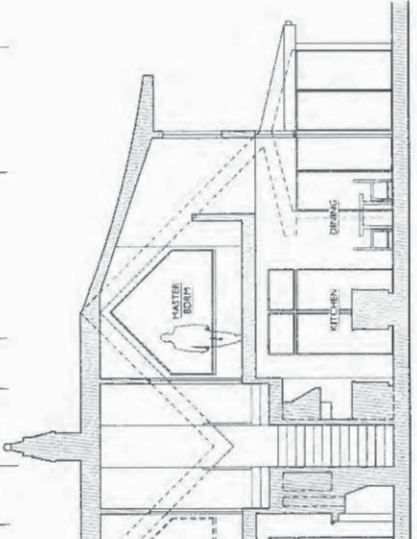

LONG SECTION - MAIN HOUSE
SCALE 1/4" = 1'-0"

1'-0" GARAGE FLOOR
1'-0" GARAGE FLOOR
1'-0" GARAGE FLOOR
1'-0" GARAGE FLOOR



CROSS SECTION - MAIN HOUSE
SCALE 1/4" = 1'-0"

LONG SECTION - MAIN HOUSE
SCALE 1/4" = 1'-0"

CROSS SECTION - MAIN HOUSE
SCALE 1/4" = 1'-0"



1.1 EXISTING SITE PHOTO - LOOKING EAST
SCALE: NONE

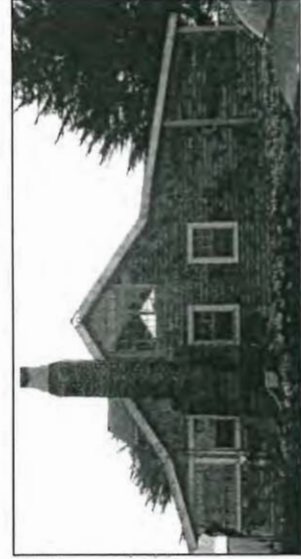

1.2 EXISTING SITE PHOTO - LOOKING EAST
SCALE: NONE



1.3 EXISTING SITE PHOTO - LOOKING WEST
SCALE: NONE



1.4 EXISTING SITE PHOTO - LOOKING NORTH
SCALE: NONE



1.5 EXISTING SITE PHOTO - LOOKING WEST
SCALE: NONE



1.6 EXISTING SITE PHOTO - LOOKING EAST
SCALE: NONE

REVISIONS
 DATE: _____
 REVISIONS: _____
 PROJECT: MALIK RESIDENCE
 SHEET NO: C-2



GRADING AND UTILITY PLAN
 MALIK RESIDENCE
 115 WEST POINT AVENUE
 EL GRANADA (SMCO) CA 94019
 04/23/2014
 T = 10'
 A.P.
 TRL
 C-2
 REC-14-0029

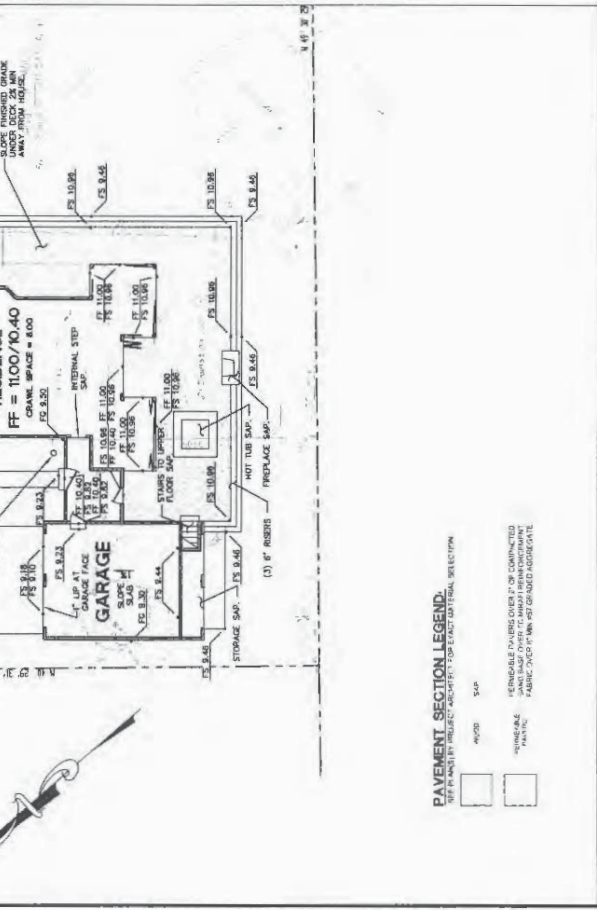
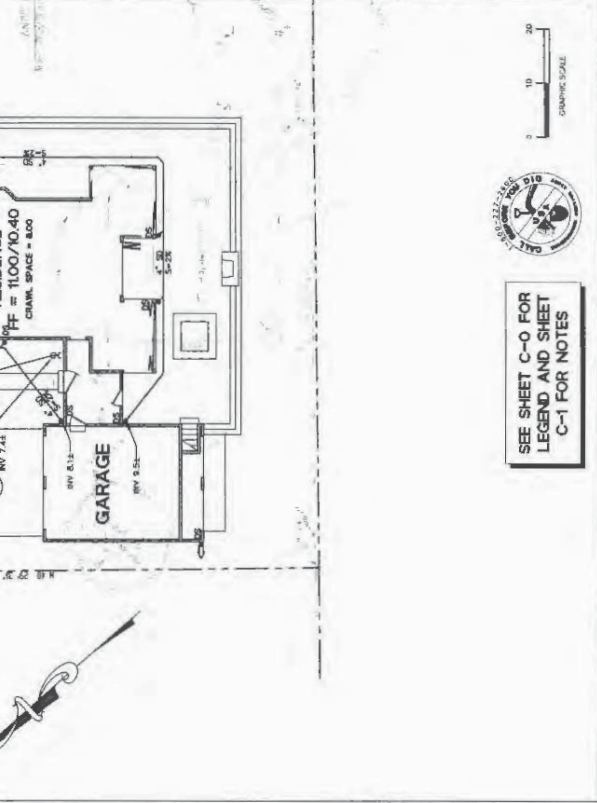
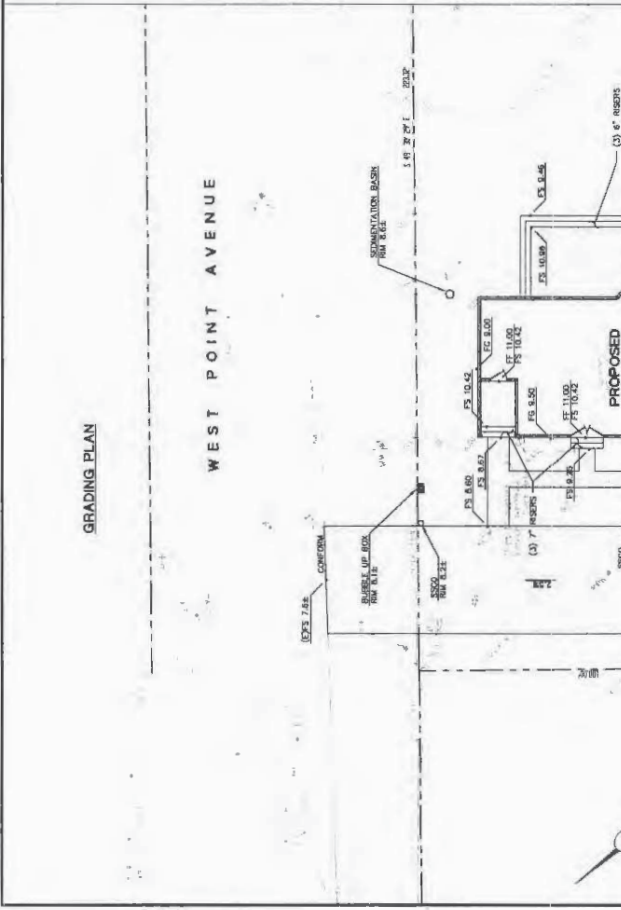
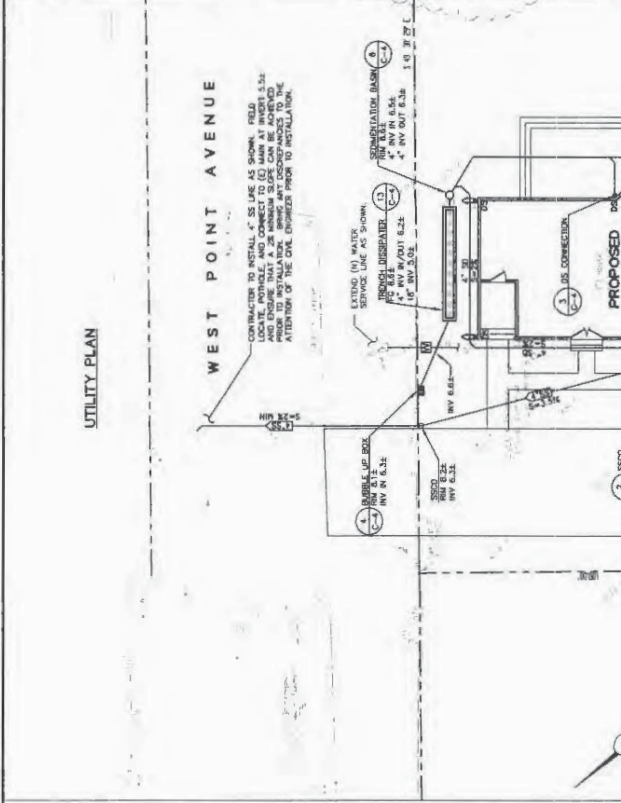

PAVEMENT SECTION LEGEND.
 ASPHALT
 4" (4) 1/2" ASPHALT
 4" (4) 1/2" ASPHALT
 4" (4) 1/2" ASPHALT

1. FERTILIZABLE FILLERS OVER 2" OR COMPACTED SAND BASE OVER 12" ABOVE FINISH GRADIENT
 2. 1/2" (2) 1/2" PUBLIC STREETS OR PRIVATE DRIVEWAY

Construction Best Management Practices (BMPs)

Construction projects are required to implement the stormwater best management practices (BMP) on this page, as they apply to your project, all year long.

SAN RATED COUNTY WIDE
Water Pollution Prevention Program
Clean Water. Healthy Community.

Materials & Waste Management

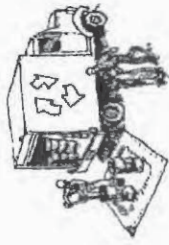

Non-Hazardous Materials

- Use firm and cover any piles of sand, dirt or other construction material with tarp which can be forecast or if not available, being used within 14 days.
- Use flat low-profile (scrimed) water for dust control.

Hazardous Materials

- Label all hazardous materials and hazardous wastes (such as pesticides, paints, thinners, solvents, fuel, oil, and antifreeze) in accordance with city, county, state and Federal regulations.
- Store hazardous materials and wastes in water tight containers, provide appropriate secondary containment and cover them at the end of every work day or during wet weather or when rain is forecast.
- Follow manufacturer's application instructions for hazardous materials and use caution not to use more than necessary. Do not apply chemicals outdoors when rain is forecast to fall in 24 hours.
- Arrange for appropriate disposal of all hazardous wastes.

Waste Management

- Cover a site disposal container securely with tarp at the end of every work day and during wet weather.
- Check water disposal containers frequently for leaks and to make sure they are not overfilled. Never hose down a dumpster on the construction site.
- Clean or replace portable toilets and empty them frequently for leaks and spills.
- Dispose of all waste and debris properly. Recycle materials and wastes that can be recycled such as asphalt, concrete, aggregate, lime, and steel.
- Dispose of paint and solvents from paint, thinner, solvent, glue, and epoxy that are hazardous waste.

Construction Practices and Performance

- Establish and maintain effective erosion controls and stabilize all exposed areas with approved erosion control practices.
- Inspect for erosion control practices and track log off site.
- Verify or monitor erosion tracking, and ensure erosion control practices are in place.
- Use sediment traps to prevent further tracking. Never hose down streets to clean up tracking.

Equipment Management & Spill Control



Maintenance and Parking

- Designate an area, lined with appropriate BMPs, for vehicle and equipment parking and storage.
- Perform major maintenance, repair jobs, and vehicle and equipment washing off site.
- If washing or vehicle maintenance must be done inside work in a hatched area away from storm drains and on a tarp that can be forecast or if not available, being used within 14 days.
- Recycle or dispose of fluids in hazardous waste.
- If vehicle or equipment cleaning must be done, provide clean water only, in a hatched area that will not drain into storm drains, streets, ditches, or surface waters.
- Do not clean vehicle or equipment using steam cleaning equipment, etc.

Spill Prevention and Control

- Keep spill cleanup materials (bags, absorbents, etc.) available at the construction site at all times.
- Inspect vehicles and equipment for leaks, fuel, oil, and coolant leaks promptly. Use drip pans to catch leaks until repairs are made.
- Clean up spills or leaks immediately and dispose of cleanup materials properly.
- Do not hose down surfaces where fluids (oil, spill, etc.) are cleaned up.
- Use dry cleanup methods (absorbent materials, etc.)
- Sweep up spilled dry materials immediately. Do not use water to clean up spills.
- Clean up spills on dirt areas by digging up and properly disposing of contaminated soil.
- Report significant spills immediately. You are required by law to report all significant releases of hazardous materials, including oil, to your spill (1) Dial 911 or your local emergency response number; 2) Call the County's Office of Environment, Services, Warning Center; (916) 221-5341 (24 hours).

Earthwork & Contaminated Soils



Erosion Control

- Schedule grading and excavation work for dry weather only.
- Stabilize all hatched areas, roads, and maintenance areas, erosion control, mulch, or other erosion control measures.
- Seed or plant vegetation to establish ground cover on slopes or where construction is not immediately planned.

Sediment Control

- Protect storm drain inlet gutters, ditches and drainage courses with appropriate BMPs, such as pile of bags, filter socks, berms, etc.
- Prevent sediment from migrating off-site by installing and maintaining sediment control structures such as filter socks, silt fences or sediment basins.
- Keep excavated soil on the site where it will not collect into the street.
- Transfer excavated materials to dump trucks on the site, not in the area.
- Contaminated Soils
- If any of the following conditions are observed, test for contamination and report to the Regional Water Quality Control Board:
 - Unusual odors, fumes, or vapors
 - Abandoned underground tanks
 - Abandoned wells
 - Barrel barrels, drums, or tanks

Paving/Asphalt Work



- Avoid mixing and soil coming in wet weather or when rain is forecast before fresh pavement is all laid down, to cure.
- Cover storm drain inlets and catch basins when applying seal coat, tack coat, slurry seal, fog seal, etc.
- Collect and recycle or appropriately dispose of excess slurry, gravel or sand.
- Do NOT sweep or wash down storm drains.
- Do not use water to wash down fresh asphalt concrete pavement.

Sawcutting & Asphalt Concrete Removal

- Complete saw cut or horizontal storm drain inlets when saw cutting. Use filter bags, catch basins and filters, or gravel bags to keep slurry out of the storm drain system.
- Shovel absorbent or vacuum catch basins and dispose of all wet pavement slurry and debris in the storm drain at the end of each work day (including on weekends).
- If sawcut slurry enters a catch basin, clean it up immediately.

Concrete, Grout & Mortar Application



- Store concrete, grout and mortar under cover on pallets and away from drainage areas. These materials must never reach a storm drain.
- Wash out concrete equipment (mixers, trucks) off-site or in a contained area so there is no discharge into the underlying soil or into surrounding areas. Use concrete washout and dispose of it at garbage disposal.
- Collect the wash water from washing equipment and dispose of it in an appropriate disposal facility.

De-watering

- Effectively manage all runoff, all runoff within the site, and all runoff that may be discharged into the storm drain system. Runoff from all disturbed areas or otherwise ensure runoff does not reach storm drain.
- When dewatering, notify and obtain approval from the local municipality before discharging water to a street gutter or storm drain. Filtration or diversion through a basin, tank, or sediment trap may be required.
- In areas of known contamination, testing is required prior to reuse or discharge of groundwater. Consult with the Engineer in Charge to determine whether testing is required and what testing procedures should be followed. Groundwater must be tested for leachate off-site for proper disposal.

Painting & Paint Removal



Painting Strategy

- Use or clean brushes or mix paint containers into a sealed pail, storm drain, or surface water.
- For water-based paints, paint out to water to the extent possible. Rinse to the secondary street once you have gained permission from the local wastewater treatment authority. Never pour paint down a drain.
- For oil-based paint, paint out to brushes to the extent possible and then to storm drain. Collect and dispose of paint, thinner, and solvents in a hazardous waste container and dispose of it at an appropriate disposal facility.

Paint Removal

- Chemical paint stripping outside and slurry and dust from interior paint and primer containing lead or other toxic materials be disposed of as hazardous waste.
- Paint chips and dust from non-hazardous dry stripping and sand blasting may be swept up or collected in plastic, drop sheets and disposed of as trash.

Landscape Materials



- Common use of landscape materials and debris, such as mulch, topsoil, and potting soil.
- Stack erodible landscape material on pallets. Cover or store these materials when they are not actively being used or applied.
- Discontinue application of any erodible landscape material within 2 days before a forecast rain event or during wet weather.

OFFICE: 916.221.5341 FAX: 916.221.5342

DATE:	
REVISIONS:	



BEST MANAGEMENT PRACTICES
MATEK RESIDENCE
 115 WEST POINT AVENUE
 EL GRANADA (SMCO) CA 94019

DATE: 04/23/2014
 AS SHOWN
 TRAIL
C-31
 REC: 14-028

DATE:	
REVISION:	

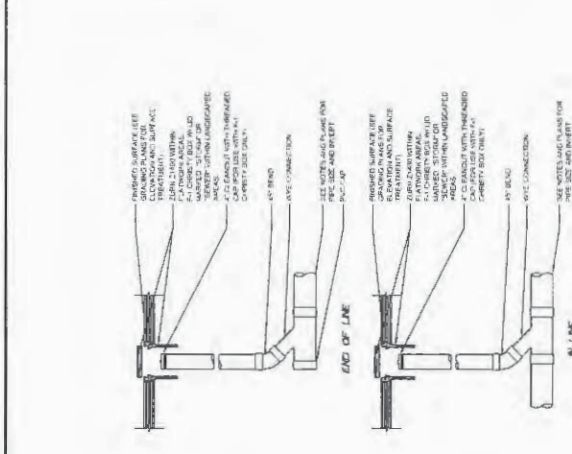

2 CLEANOUT NON-TRAFFIC RATED
 SCALE: 3/8\"/>

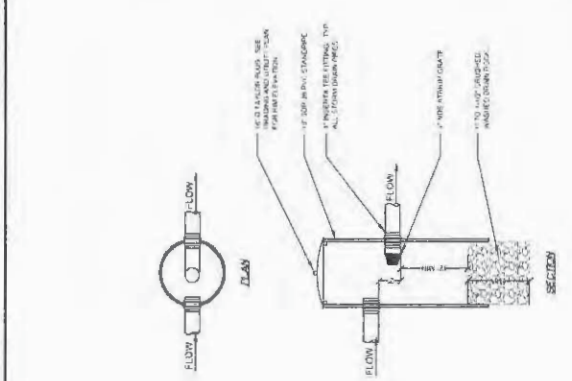

6 SEDIMENT BASIN
 SCALE: 3/8\"/>

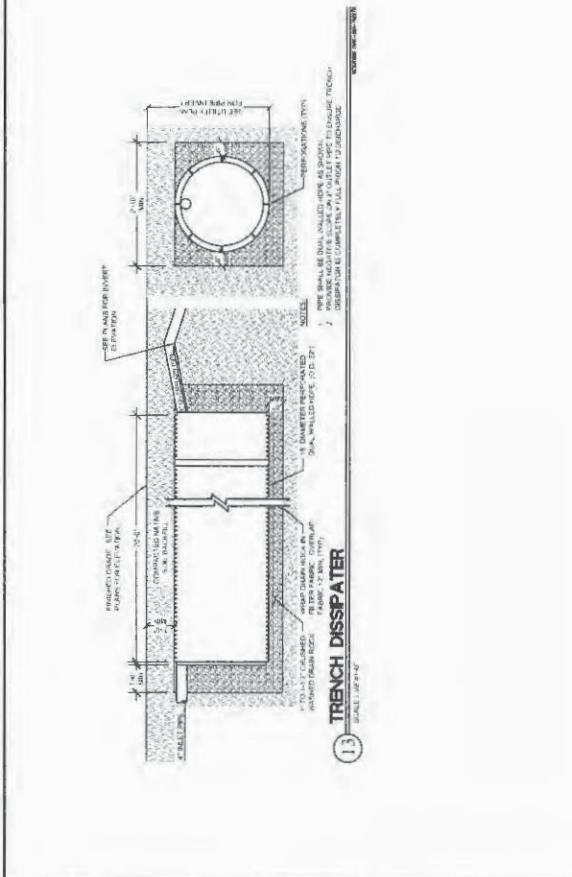

13 TRENCH DISSIPATER
 SCALE: 3/8\"/>

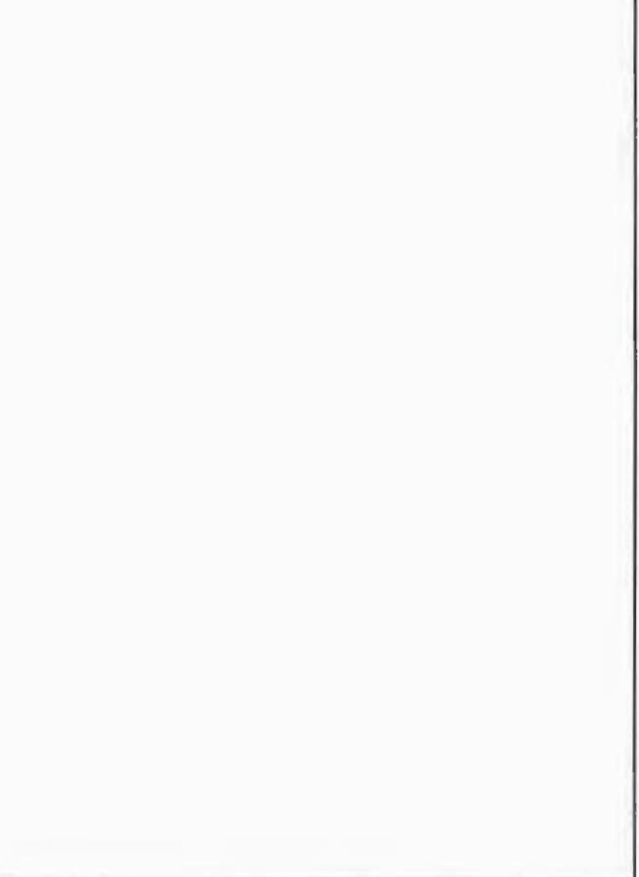
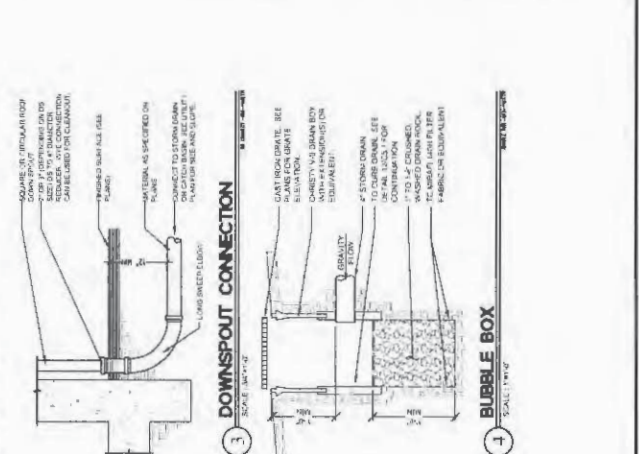

3 DOWNSPOUT CONNECTION
 SCALE: 3/8\"/>

1 BUBBLE BOX
 SCALE: 1/4\"/>

September 12, 2014
2995-2

Mr. Michael Paravati
c/o Paravati Construction
945 Durlston Road
Redwood City, California 94062

RE: GEOLOGIC FEASIBILITY EVALUATION
MALEK RESIDENCE
115 WEST POINT AVENUE
PRINCETON-BY-THE-SEA
SAN MATEO COUNTY, CALIFORNIA

Dear Mr. Paravati:

This letter presents the results of our geologic feasibility evaluation for the proposed addition to the Malek residence at 115 West Point Avenue (APN 047-032-160) in Princeton-by-the-Sea, an unincorporated area of San Mateo County near El Granada, California. In particular, we have evaluated the potential for ground surface rupture at the site by the San Gregorio/Seal Cove Fault, which is considered to be active by the County.

The Malek property at 115 West Point Road is located approximately 100 feet north of the beach along the north shore of the Pillar Point Harbor. The approximate location of the site is shown on the Vicinity Map, Figure 1.

Our work included review of geologic maps, published reports and investigations, and a review at the County offices of reports summarizing geologic and fault studies performed in the immediate vicinity of the subject property. This information was used to evaluate the feasibility of the proposed addition to the residence and to address the potential for geologic hazards to affect the residence and the proposed addition.

Based on the published information and reports we reviewed, we have concluded that the primary trace of the San Gregorio/Seal Cove Fault is located west of the subject site, and that there are no indications of the potential for ground surface rupture at the site from the primary trace of the San Gregorio Fault or splays from the fault.

PROJECT DESCRIPTION

The project consists of major remodeling and construction of an addition to the two-story 1930s vintage cottage at the subject site. Since the existing cottage does not conform to current lot line setback standards, the proposed project intends to amend the setback non-conformance by combining the existing lot with the adjacent lot (APN 047-032-170). The addition is expected to add approximately 1,100 square feet to the cottage footprint and approximately 2,000 square feet of total living space including a two-car garage with an office/guest suite above. The existing deck will be renovated and expanded to extend around the southeast and southwest sides of the residence.

LIMITATIONS

This geologic feasibility study has been prepared for the exclusive use of Mr. Michael Paravati for specific application to the proposed remodeling and addition to the Malek residence at 115 West Point Avenue in Princeton-by-the-Sea. We make no warranty, expressed or implied, for the services we perform for this project. Our services are performed in accordance with geologic and geotechnical engineering principles generally accepted at this time and location.

The analysis and conclusions presented in this feasibility study report are based on review of reports and investigations for property in the vicinity of the subject site. The opinions and conclusions presented in this letter are based solely on review of available documents. Certain limitations are inherent in this type of feasibility evaluation, and subsurface exploration was not performed as part of this study.

A design-level geotechnical investigation that includes subsurface exploration should be performed to evaluate geotechnical conditions at the site. Information or data gathered from a design-level geotechnical investigation could result in changes to the conclusions that have been reached based on the geologic work that has been performed to date.

GEOLOGIC SETTING

The Malek property is located on an uplifted marine terrace along the northwest side of Pillar Point Harbor adjacent to the Pacific Ocean. Based on published geologic maps, the site is underlain by Pleistocene-age marine terrace deposits (Pampeyan, 1994). The deposits are expected to consist of poorly to moderately consolidated marine, eolian, and alluvial sand, silt, gravel, and clay in various proportions in indistinct to distinct lenses and beds. A marsh area west of the subject site is underlain by Holocene-age fine-grained alluvial deposits consisting of unconsolidated, poorly sorted, plastic, organic clay, and silty clay in poorly drained interfluvial basins. The geology of the general area of the site is shown on the Vicinity Geologic Map, Figure 2.

The site is situated within an area considered to have the potential for ground surface rupture along the San Gregorio / Seal Cove Fault. The potential for ground surface rupture at the site is discussed in subsequent sections of this letter.

The Tsunami Inundation Map for Emergency Planning (2009) indicates the site is within a tsunami hazard zone. Areas mapped within a tsunami hazard zone may be affected by a series of waves or surges following a large earthquake in or along the Pacific Ocean.

The site and the immediately surrounding area are relatively flat with no indications of landslides or earth movement.

NEARBY INVESTIGATIONS

A geotechnical investigation was performed northwest of the site at 179 West Point Avenue by Buckley Engineering Associates (2001). The site at 179 West Point Avenue is located approximately 50 feet northwest of the subject site. Subsurface exploration consisted of advancing two exploratory borings that encountered clay with intermittent lenses of silty sand. The borings extended to a depth of approximately 12 feet below the ground surface. Based on their work, Buckley Engineering Associates concluded there was no indication that faulting would affect the proposed development or the property.

In 1990, Earth Sciences Associates (ESA) prepared a geologic and geotechnical report for the El Granada Mobile Home Park, which is located approximately 2,300 feet northwest of the site, prior to construction of water tanks and a retaining wall on the property. This investigation included advancing exploratory borings and excavating two fault trenches. The fault trenches were located along the base of the east-facing bluff, where the primary fault trace has been mapped. There were no indications of faulting within the trenches during the initial study or during construction, although a linear, soft zone was observed during construction. This soft zone was deemed to be a depositional feature by ESA after the second fault trench was completed. Based on their investigation, ESA concluded the fault is not located in the area of the water tanks, although it is likely the fault is located within 100 feet of the tanks, probably to the east.

SITE RECONNAISSANCE

Our geologist performed a surface reconnaissance of the area on September 4, 2014 consisting of walking the subject site, nearby properties, and roads to observe surficial features. The existing residence at the site and the adjacent structures on neighboring properties appeared to be in satisfactory condition. The subject site appears to have been graded to create the level building pad, which may have modified or destroyed any fault related features. The building pad for the residence is located approximately 12 feet above sea level and 5 feet above the surface of the marsh. No indications of faulting were observed on the subject site.

Our site reconnaissance included observation of surficial features within the adjacent marsh area, along West Point Avenue extending to Pillar Point, the harbor shoreline, and San Mateo County park areas northwest of the site near the El Granada Mobile Home Park. There were no indications of active faulting or surface ruptures along the trace of the San Gregorio/Seal Cove Fault (where viewed as mentioned above), although the dense vegetation and the recent fluvial activity and deposition in the marsh and harbor would likely cover any features related to Holocene fault movement.

FAULT ZONE RESEARCH

The Malek property is located along the northeast boundary of the State of California Earthquake Fault Zone (formerly known as a Special Studies Zone) on the Montara Mountain Quadrangle (1982), due to the presence of the active San Gregorio/Seal Cove Fault southwest of the site. Published and unpublished investigation reports have identified

the San Gregorio/Seal Cove Fault within the immediate vicinity of the site along with a series of “splay faults” near Moss Beach, which is located northwest of the subject site. The splay faults are presumed to be related to the San Gregorio/Seal Cove Fault and are variously located on published maps oriented sub-parallel to and west of the primary fault trace. The following discussion provides a review of investigations and reports related to the fault in the immediate vicinity of the subject site.

Published geologic maps (Simpson, et al, 1997; Kenneth and Lajoie, 1980; Pampeyan, 1994; William Lettis & Associates, Inc., 2000; William Lettis & Associates, Inc., 2005) locate the primary trace of the San Gregorio/Seal Cove Fault approximately 400 feet west of the site within the low-lying marsh (as shown on Figures 3, 4, 5, and 6). Topographic evidence (including uplifted west bluff, east-facing scarp, deformed marine terrace, and the low-lying basin/marsh) indicates the fault extends northwest from the marsh along the east-facing scarp. The location of the fault near the subject site and within the marsh area was confirmed by fault trenching within the Seal Cove Gap (Simpson, et al, 1997; see Figure 5) and at the base of the Seal Cove Bluffs (William Lettis & Associates, Inc., 2005; see Figure 3).

A study by Jack (1969) indicates the presence of a northeast-facing scarp on the ocean floor to the southwest, which may indicate the location of the fault beneath the harbor. The subject site is located northeast of this scarp, as shown on Figure 5.

Simpson, et al (1997) concluded that the mapped fault as identified in their study represents the eastern-most fault feature within the broad zone of the San Gregorio/Seal Cove fault system and that other faults within the fault system would lie offshore to the west, with the exception of a small west-facing scarp across a Holocene-aged alluvial fan of Denniston Creek, which is located approximately 3,500 feet northeast of the subject site (See Figure 2). Fault splays extending from the primary trace were mapped by William Cotton and Associates (1980) and are shown extending to the west of the fault in general agreement with conclusions by Simpson, et al (1997).

Review of Google Earth imagery and a subsequent overlay displaying the approximate location of Alquist Priolo Earthquake Fault Zone indicates a “trace” of a fault trending toward the subject site from the southeast beneath the harbor. Our research did not indicate the basis or source for the mapped fault trace.

AERIAL PHOTOGRAPHS

Two sets of stereo pair aerial photographs were viewed and interpreted for this study. The images were flown in 1931 and 1941, and ranged in scale from 1:18,000 to 1:24,000. These images are listed in the References section of this report. The existing residence is present in both photo imagery sets. The residence is located on an elevated terrace adjacent to the beach. The surrounding area on the north and northeast is developed as agricultural fields. The ground surface is thus disturbed and fault-related features may be obscured. However, there are no apparent lineations or tonal features projecting toward the site and thus no indications of prior ground surface rupture.

CONCLUSIONS AND RECOMMENDATIONS

In our opinion, there are no indications in the published geologic literature of active faults trending toward or beneath the subject site. Based on our review of published and unpublished reports and maps, the primary trace of the San Gregorio/Seal Cove Fault is located west of the subject site.

Due to the proximity to the San Gregorio/Seal Cove Fault, severe ground shaking should be anticipated at the site during an earthquake along this fault system.

Although we do not believe that fault trenching is required to confirm the conclusions from our geologic review, a design-level geotechnical investigation including subsurface exploration should be completed to address the geotechnical conditions at the site and to provide earthwork guidelines and foundation design criteria for the proposed remodeling and addition to the residence.

Please call if you have questions or comments about the findings and conclusions from the geologic feasibility study summarized in this letter report.

Very truly yours,

ROMIG ENGINEERS, INC.

Christina Tipp

Christina M. Tipp
Senior Staff Geologist

Richard G. Woodard

Richard G. Woodard, P.E., G.E.



David F. Hoexter

David F. Hoexter, P.G., C.E.
Expires 11/30/15

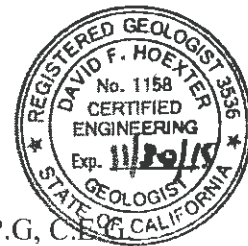

Attachments:

- List of References
- Figure 1 – Vicinity Map
- Figure 2 – Vicinity Geologic Map
- Figure 3 – Geologic Map Excerpt (William Lettis & Associates, 2005)
- Figure 4 – Geologic Map Excerpt (William Lettis & Associates, 2000)
- Figure 5 – Geologic Map Excerpt (Simpson et al, 1997)
- Figure 6 – Geologic Map Excerpt (Lajoie and Weber, 1980)

Copies: Addressee (1)
McGriff Architects (4)
Attn: Mr. Benjamin McGriff

REFERENCES

Aerial Photographs

United States Geologic Survey Library, Menlo Park, California (USGS); USDA (United States Department of Agriculture Adjustment Administration (CIV series); WAC Corporation, Eugene, Oregon (WAC); Fairchild Aerial Photography Collection (FAPC); and Pacific Aerial Surveys, Oakland, California (PAS): black and white vertical stereo pairs, except as noted.

Source	Imagery	Date	Scale
FAPC	6600-6/7	3/23/41	1:24,000
FAPC	C-1471-122/123	3/30/31	1:18,600

Publications and Reports

Brabb, Graymer and Jones, 2000, Geologic Map of the Palo Alto 30' x 60' Quadrangle, California: U.S. Geological Survey Miscellaneous Field Studies Map MF-2332, U.S. Geological Survey, Menlo Park, CA.

Buckley Engineering Associates, Inc, November 24, 2001, Geotechnical Investigation, 179 West Point Avenue, Half Moon Bay for Ms. Joan Mullins, Job No. 014821.

California Department of Conservation, Division of Mines and Geology (DMG), 1994, Fault-Rupture Hazard Zones in California, Special Publication 42.

California Division of Mines and Geology, (CDMG), 1982, State of California Special Studies Zone, Montara Mountain Quadrangle, (Alquist-Priolo Earthquake Fault Zones).

California Emergency Management Agency, et al, 2009, Tsunami Inundation Map for Emergency Planning, State of California, County of San Mateo, Montara Mountain Quadrangle, June 15, 2009.

Earth Sciences Associates (ESA), April 17, 1990, Geotechnical Report: Water Treatment Plant and Storage Reservoirs, Water distribution and Sewer Systems at El Granada Mobile Home Park, Project No. 3433.

Earth Sciences Associates, November 1, 1990, Site Visits to El Granada Water Tanks Construction Site to Evaluate Foundation Conditions and Possible Faulting in Site Area.

Jack, R. N., 1969, Quaternary sediments of the Montara Mountain area, San Mateo County, California, unpublished Master's Thesis, University of California, Berkeley.

REFERENCES
(Continued)

Pampeyan, E.H., 1994, Geologic Map of the Montara Mountain and San Mateo 7.5 Minute Quadrangles, San Mateo County, California, U.S. Geological Survey Map I-2390.

Schwartz, D.P., 1994, New Knowledge of Northern California Earthquake Potential, in Proceedings of Seminar on New Developments in Earthquake Ground Motion Estimation and Implications for Engineering Design Practice, Applied Technology Council.

Simpson, G. D., Thompson, S. C., Noller, J. S., Lettis, W. R., 1997, The Northern San Gregorio Fault Zone: Evidence for the Timing of Late Holocene Earthquakes near Seal Cove, California, Bulletin of the Seismological Society of America, Vol. 87, pp. 1158-1170.

William Cotton and Associates, August 5, 1980, Geologic Analysis of the Seal Cove Area, County of San Mateo.

William Lettis & Associates, Inc, May 2000, Paleoseismic Investigation of the Northern San Gregorio Fault at Pillar Point Marsh Near Half Moon Bay, California, prepared for the U.S. Geological Survey Western Region, Contract No. 98WRCN1012.

William Lettis & Associates, Inc, May 2005, Final Technical Report, Paleoseismic Investigation of the Northern San Gregorio Fault, Half Moon Bay, California, U.S. Geological Survey, National Earthquake Hazards Reduction Program, Award No. 04HQGR0045.

Working Group on California Earthquake Probabilities (WGCEP), 2008, The Uniform California Earthquake Rupture Forecast, Version 2 (UCERF 2), U.S. Geological Survey Circular Open File Report 2007-1437.



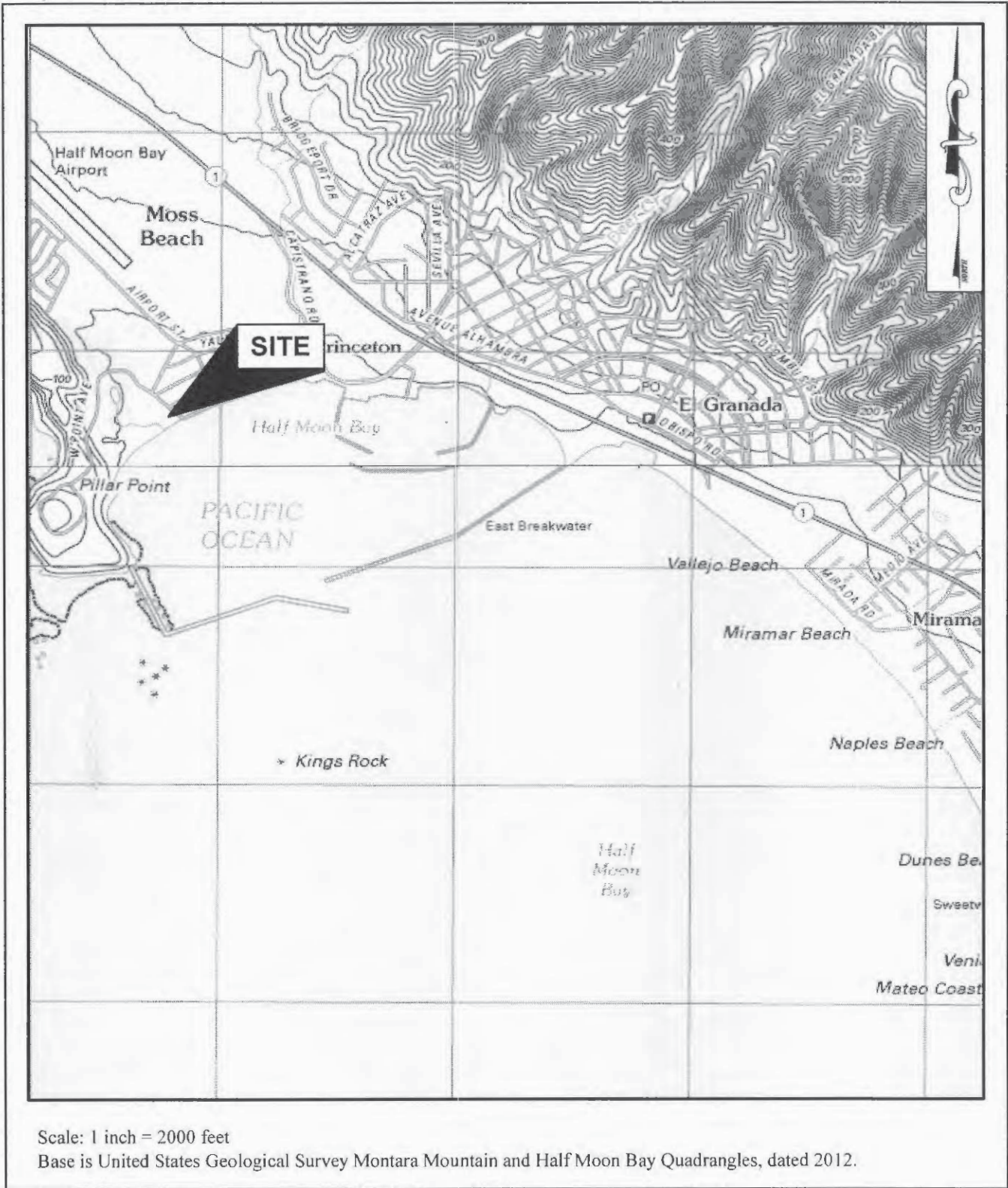

VICINITY MAP
 PARAVATI GEOLOGIC FEASIBILITY EVALUATION
 PRINCETON-BY-THE-SEA

FIGURE 1
 SEPTEMBER 2014
 PROJECT NO. 2995-2

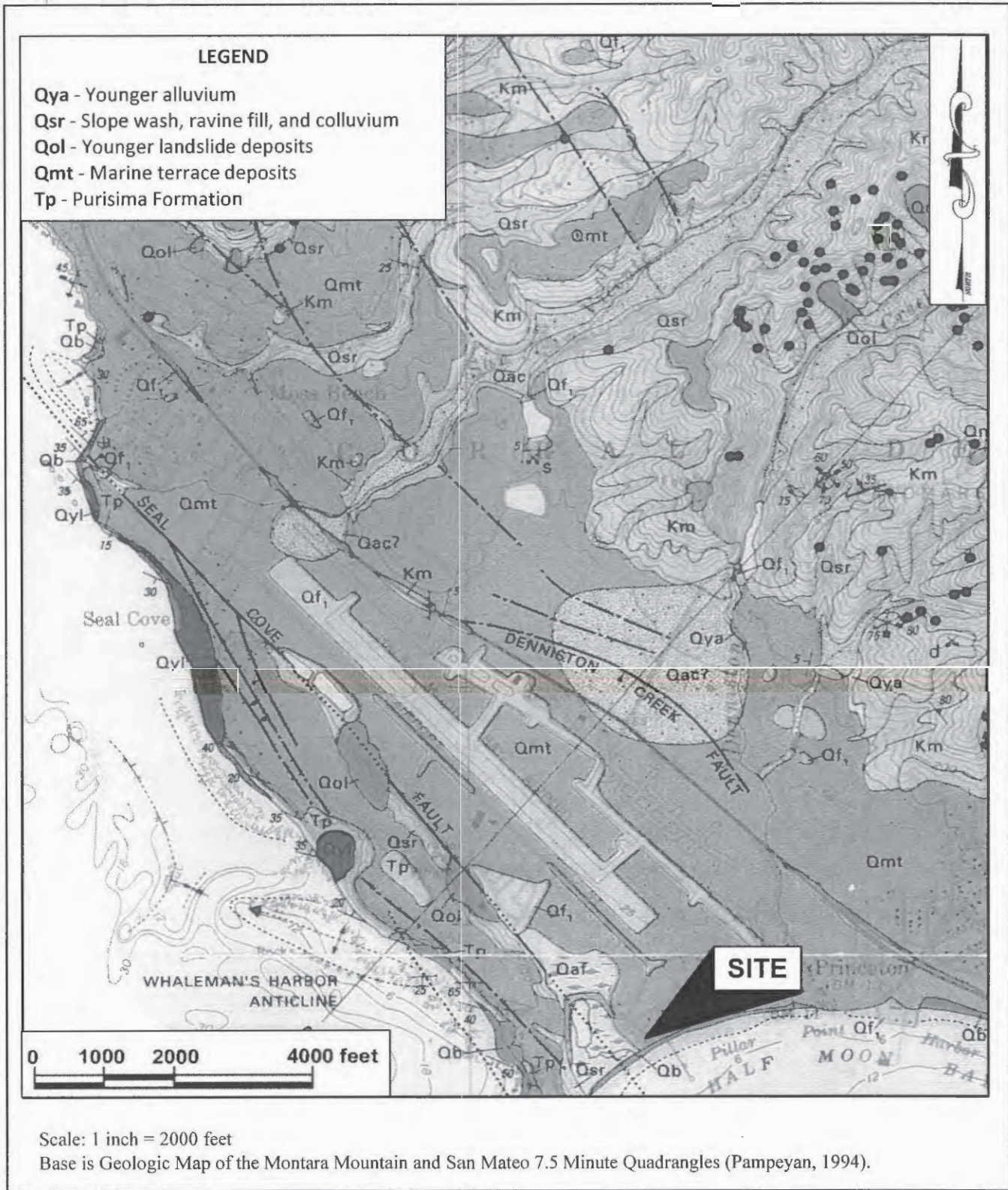

VICINITY GEOLOGIC MAP
 PARAVATI GEOLOGIC FEASIBILITY EVALUATION
 PRINCETON-BY-THE-SEA

FIGURE 2
 SEPTEMBER 2014
 PROJECT NO. 2995-2

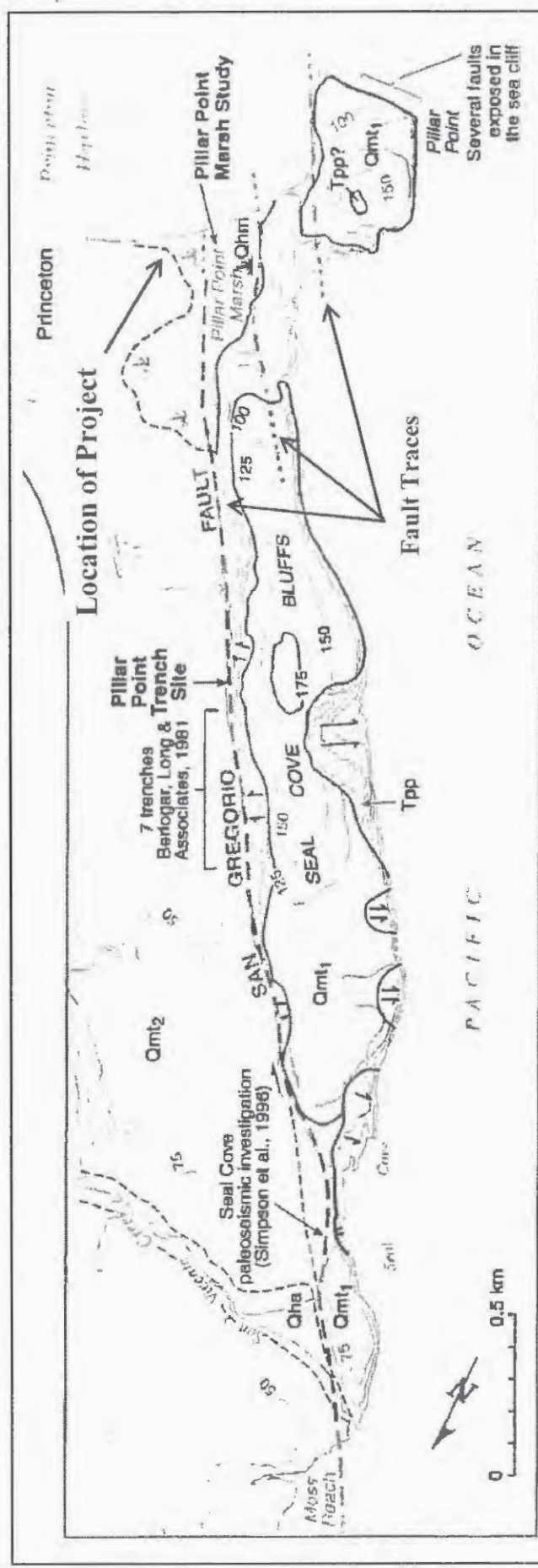

Explanation

Symbols

- Northern San Gregorio fault
- - - - - Previously mapped trace of San Gregorio fault
- Geologic contact; dashed where approximate
- (/) Landslide

Geologic Units

- Qha Holocene alluvium
- Qmt2 Marine terrace, 83,000 years old (Half Moon Bay terrace)
- Qmt1 Marine terrace, 100,000 to 125,000 years old (Seal Cove Bluffs terrace)
- Tpp Purisima Formation

Site map showing Pillar Point Marsh, Seal Cove Bluffs, and the Seal Cove reach of the northern San Gregorio fault from William Lettiss & Associates, Inc, dated May 2005.

GEOLOGIC MAP EXCERPT (WILLIAM LETTIS & ASSOCIATES, 2005)
PARAVATI GEOLOGIC FEASIBILITY EVALUATION
PRINCETON-BY-THE-SEA

FIGURE 3
 SEPTEMBER 2014
 PROJECT NO. 2995-2

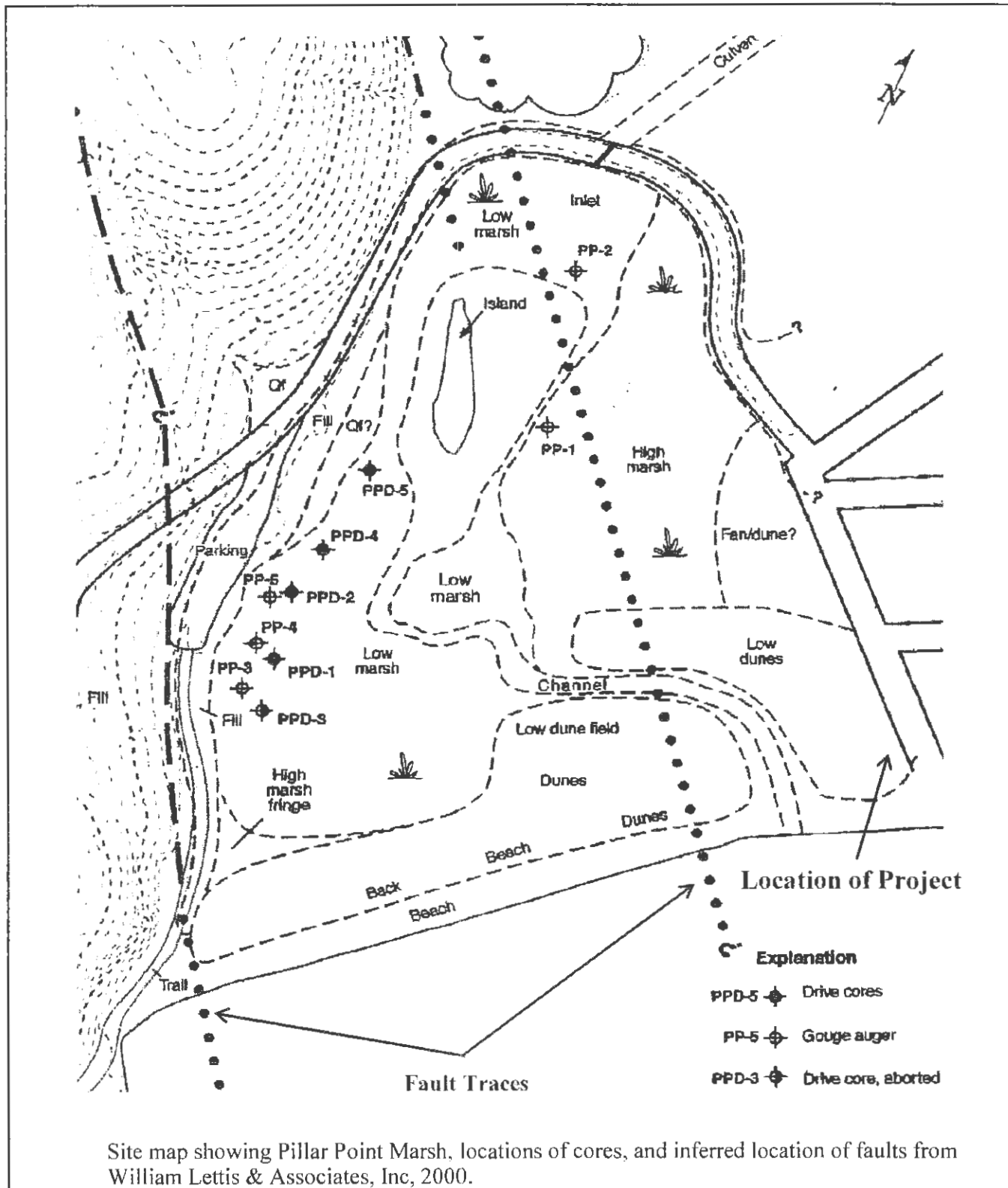

GEOLOGIC MAP EXCERPT (WILLIAM LETTIS & ASSOCIATES, 2000)
 PARAVATI GEOLOGIC FEASIBILITY EVALUATION
 PRINCETON-BY-THE-SEA

FIGURE 4
 SEPTEMBER 2014
 PROJECT NO. 2995-2

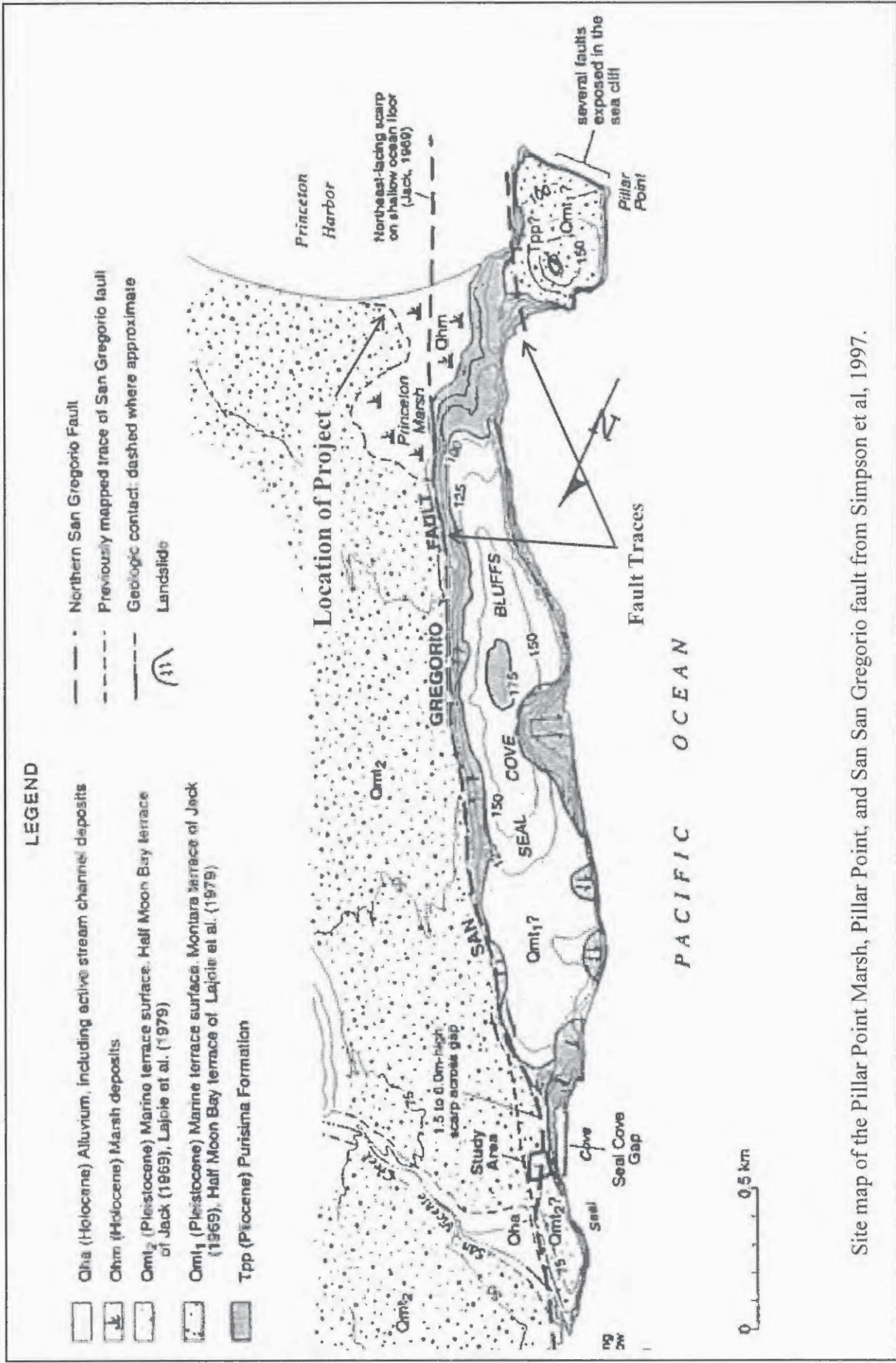

Site map of the Pillar Point Marsh, Pillar Point, and San Gregorio fault from Simpson et al., 1997.



Site map of Pillar Point Marsh and San Gregorio/Seal Cove Fault from Lajoie and Weber, 1980.

GEOLOGIC MAP EXCERPT (LAJOIE AND WEBER, 1980)
PARAVATI GEOLOGIC FEASIBILITY EVALUATION
PRINCETON-BY-THE-SEA

FIGURE 6
SEPTEMBER 2014
PROJECT NO. 2995-2



Geotechnical • Geologic • Coastal • Environmental

5741 Palmer Way • Carlsbad, California 92010 • (760) 438-3155 • FAX (760) 931-0915 • www.geosoilsinc.com

December 12, 2014

Dr. Reza Malek
c/o McGriff Architects
1475 15th Street
San Francisco, CA 94103

SUBJECT: Tsunami Runup and Force Analysis for 114 West Point Avenue, El Granada,
San Mateo County, California.

Reference: "Tsunami Inundation Map for Emergency Planning, Montara Mountain Quadrangle,"
1:24,000 scale, dated June 15, 2009, by State of California, County of San Mateo.

Dear Dr. Malek:

At your request, GeoSoils Inc. (GSI) is pleased to provide this Tsunami Runup and Force Analysis for 114 West Point Avenue in San Mateo County. The reason for the report is that the site is mapped by the State of California to be in a tsunami inundation zone (see above reference). The County of San Mateo is required to determine if the proposed development is reasonably safe from damage due to a tsunami over the life of the development. Our scope of work includes our previous inspection of the site and surrounding area, review of the available oceanographic data and tsunami information for the area (see references), analysis of tsunami propagation onto the subject site, and preparation of this report. Photograph 1, downloaded, with permission from the California Coastal Records Project web site (<http://www.californiacoastline.org/>), shows the site and the adjacent shoreline in September 2013. The site is currently occupied by a residential structure. The proposed project is a renovation and addition to the structure. The development is over 130 feet from the highest water mark surveyed on January 27, 2014. The site is fronted by a very gently sloping beach. The beach is subject to very little wave energy due to the breakwater located about 3000 feet away.

ATTACHMENT C



Photograph 1. Subject site and adjacent shoreline/development September 2013.

TSUNAMI RUNUP AND OVERTOPPING ANALYSIS

The stated purpose of the above referenced tsunami inundation map is for coastal evacuation planning only. It is not a site specific analysis of the potential impacts of a tsunami on the existing or proposed development. In order to determine potential tsunami impacts at the site, in light of future sea level rise over the life of the development (75 years), an extreme event tsunami analysis will be provided herein. There are many experts that study and publish up to date information on tsunamis including Dr. James Lander at NOAA, Dr Jose Borrero, and Dr. Costa Synolakis at the USC Tsunami Research Center (<http://www.usc.edu/dept/tsunamis/2014/index.php>). Either of these sources can provide the San Mateo County reviewer with extensive information on tsunami events. Based upon our review of the historical data and tsunami forecast modeling by the USC Tsunami Research Center, a 6.5 feet high tsunami for this area would be on the order of a 500-year recurrence interval event. For our analysis, a 6.5 feet tsunami will be the conservative, extreme, tsunami wave height.

To determine how a tsunami may impact the site, the physical setting of the site relative to the ocean needs to be discussed. As a tsunami propagates towards the site, it first encounters the breakwater at Half Moon Bay. The breakwater is located in about 30 feet of water and rises to an elevation of about +15 feet NGVD29 (~mean sea level [MSL]). The tsunami will break on or before the breakwater and then possibly overtop the structure. Depending upon the tide, some or most of the tsunami energy will be lost on the breakwater and or reflected back offshore. The portion of the tsunami that overtops the breakwater forms a critical flow bore that will then propagate across the bay to the site, a distance of about 3,000 feet. The tsunami bore will reach the shoreline and will than

propagate onto the site. Basic hydraulic modeling of this bore propagation would use the Manning Equation for open channel flow with a roughness coefficient (Manning Equation variable N) due to the vegetation. It is very important to point out that the tsunami will reach the shoreline area in the form of a bore, that is a pulse of water. It is NOT a continuous flow nor a sustained flow of water.

As a tsunami encounters the breakwater in front of the property, the wave will rush up, and sometimes over, the breakwater crest. Wave runup is defined as the vertical height above the still water level to which a wave will rise on a structure (breakwater) of infinite height. Overtopping is the flow rate of water over the top of a finite height structure (breakwater) as a result of wave runup. Wave runup and overtopping for an extreme tsunami event is calculated using the US Army Corps of Engineers Automated Coastal Engineering System (ACES). ACES is an interactive computer based design and analysis system in the field of coastal engineering. The methods to calculate runup and overtopping implemented within this ACES application are discussed in greater detail in Chapter 7 of the Shore Protection Manual (1984) and the Coastal Engineering Manual (2004). The overtopping estimates calculated herein are corrected for the effect of onshore winds. Figure 1 is a diagram showing the analysis terms.

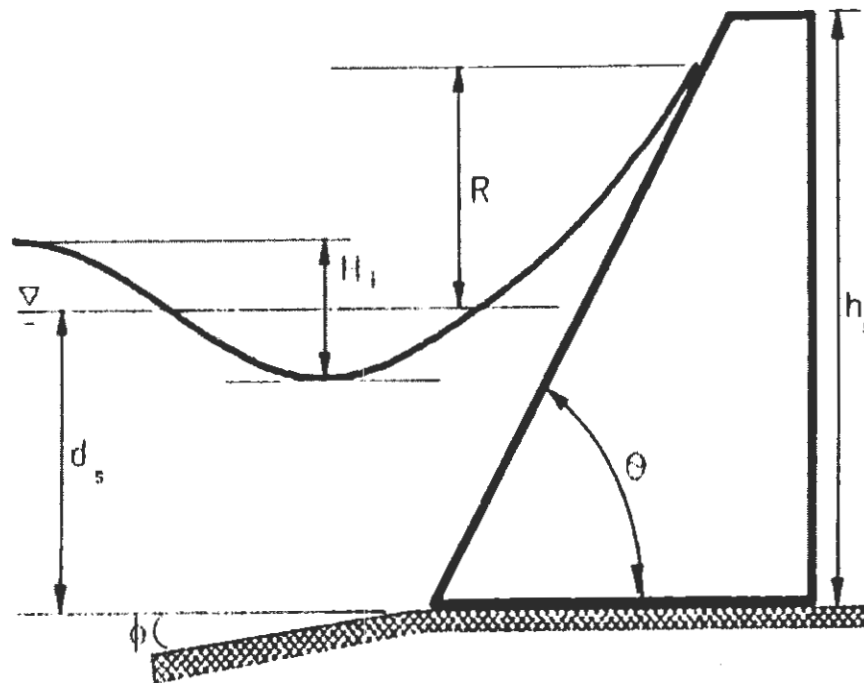

Figure 1. Wave runup terms from ACES manual.

The wave, wind, and water level data used as input to the tsunami runup and overtopping application will be the extreme tsunami height of 6.5 feet with the water level at highest recorded water level, corrected for future sea level rise (SLR). This represent the worse case scenario with a very low probability of occurrence. If the tsunami occurs at low tide it

will likely not overtop the breakwater. Figure 2 shows the spread of sea level rise projection over the next 90 years. The proposed development will have an estimated design life of 50 to 75 years. The range spread over the economic life of the proposed project is from a low of 0.5 feet (USACE/Low) to a high 4.5 feet (COPC high). The California Coastal Commission (CCC) released a Draft Sea-Level Rise (SLR) Policy Guidance document in October 2013. The document is currently undergoing revisions, and has not been finalized, approved, or officially implemented. The CCC currently proposes to adopt the National Research Council (NRC) 2012 SLR estimates (NRC is the same as COPC) of 16.56 inches to 65.76 inches over the time period from 2000 to 2100. The CCC recommendation is to use an SLR estimate in that range. The extreme water elevation at the breakwater used in this analysis is +8.5 feet NGVD29 (max recorded historical still water of 5.0 feet NGVD29 on January 27, 1983 [Monterey NOAA Tidal Station]+ 3.5 feet sea level rise). **TABLE I** is the ACES output for these design conditions.

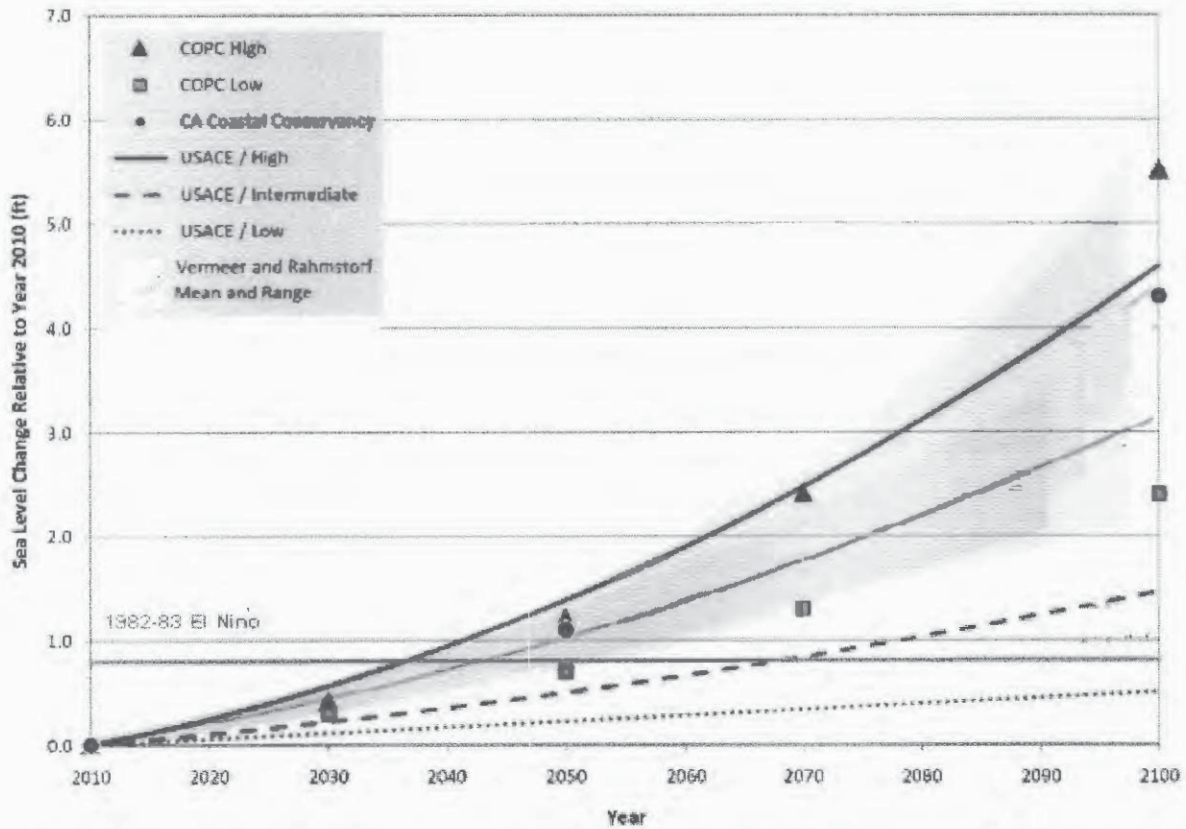

Figure 2. Range of sea level rise predictions over the next 90 years adopted from Everest International Consultants Inc. 2011.

TABLE I

ACES		Mode: Single Case		Functional Area: Wave - Structure Interaction	
Application: Wave Runup and Overtopping on Impermeable Structures					
Item		Unit	Value	Rough Slope Runup and Overtopping	
Incident Wave Height	Hi:	ft	6.500	114 West Point TSUNAMI RUNUP SLR 3.5 FEET	
Wave Period	T:	sec	30.000		
COTAN of Nearshore Slope	COT(ϕ):		180.000		
Water Depth at Structure Toe	ds:	ft	30.000		
COTAN of Structure Slope	COT(θ):		1.500		
Structure Height Above Toe	hs:	ft	35.000		
Rough Slope Coefficient	a:		0.956		
Rough Slope Coefficient	b:		0.398		
Wave Runup	R:	ft	13.677		
Onshore Wind Velocity	U:	ft/sec	33.756		
Deepwater Wave Height	H0:	ft	4.092		
Relative Height	ds/H0:		7.332		
Wave Steepness	H0/(gT ²):		0.000141		
Overtopping Coefficient	α :		0.050000		
Overtopping Coefficient	Qstar0:		0.140000		
Overtopping Rate	Q:	ft ³ /s-ft	3.581		

The calculated overtopping rate of the breakwater with 3.5 feet of future SLR is 3.6 ft³/s-ft. For the calculated overtopping rate the height of water can be calculated using the following empirical formula provided by the USACOE (Protection Alternatives for Levees and Floodwalls in Southeast Louisiana, May 2006, equation 3.1) based upon the calculated overtopping rate Q for the 3.5-foot SLR case.

$$q = 0.5443\sqrt{g} \cdot h_1^{3/2}$$

Therefore, for SLR of 3.5 feet with an overtopping rate of 3.6 ft³/s-ft the water height h_1 = 1.1 feet. The overtopping waters will propagate across the bay with some loss in elevation due to friction. For conservative analysis, assume that the height of the tsunami bore is 1 feet when it reaches the shoreline. The US Army Corps of Engineers Coastal Engineering Manual (CEM) states that for every 25 feet that a wave overtopping travels across the beach, the height of the runup bore is reduced by 1 foot. The distance from the shoreline to the closet portion of the development is over 100 feet. It is unlikely that the

tsunami bore will reach the site and even if it does the bore height will be less than 1 foot.

The proposed development has a very low but not zero probability of being subject to some tsunami runup. The runup will be less than 1 foot in height for the reasons detailed above. The methodology for calculating wave forces on a building/wall is contained in Chapter VI-5 of the US Army Corp of Engineers CEM (2004). This method is reasonably conservative and consistent with the standard of practice. Figure 3 below shows the terms used in the calculation.

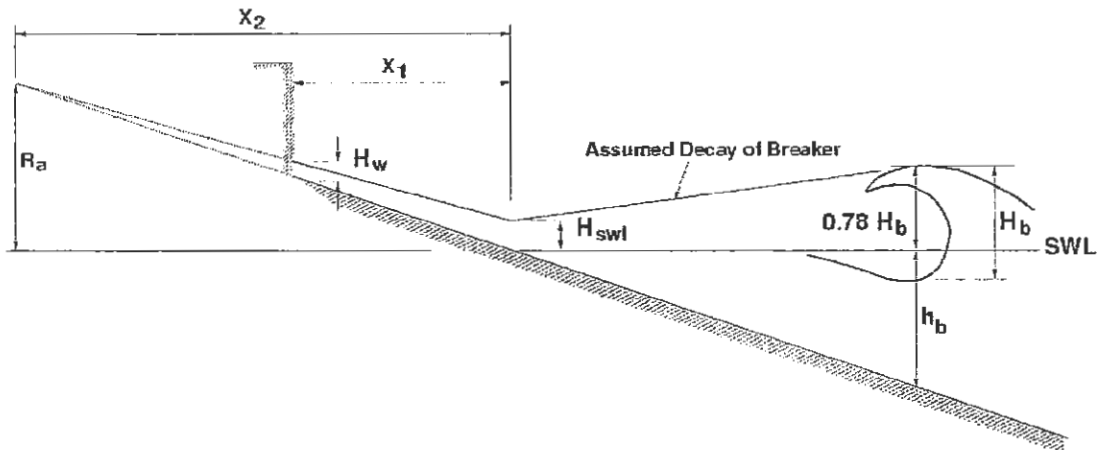

Figure 3. Broken wave force on wall/building/footing from the CEM.

The formula for the force of the broken wave surge is:

$$F_{\text{surge}} \approx 4.5 \rho g H_w^2$$

Using a H_w of 0.75 feet the calculation yields a $F_{\text{surge}} = 160$ lbs/ft. This force is the horizontal force of the bore or wave surge on the wall of the building. This force is not considered significant as compared to dynamic forces on the building due to seismic acceleration of the building mass. In addition, the proposed finished floor is about 1.5 feet above the existing grade. Therefore, it is unlikely that the building will be subject to flooding.

SAN MATEO COUNTY TSUNAMI REVIEW SCOPE OF WORK

GSI is please to respond possible concerns that may be raised by San Mateo County (SMC) officials. For ease of review the possible concerns are provided in italics followed by our response.

PURPOSE: The purpose of this report is to demonstrate that the design of the proposed development complies with Section 6326.2(b) of the San Mateo County Zoning Regulations (Tsunami Inundation Area Criteria).

Does the design of the project, as described in the plans, comply with Section 6326.2 of the Zoning Regulations?

It is GSI's opinion that the development as proposed complies with Section 6326 of the SMC Zoning Regulations.

A. Section 6326.2(b) of the San Mateo County Zoning Regulations: This section provides the following criteria for Residential Structures proposed in areas designated as "Tsunami Inundation Areas". Section (b) states "residential structures and resort developments designed for transient or other residential use may be permitted under the following circumstances":

1. The applicant submits a report prepared by a competent and recognized authority estimating the probable maximum wave height, wave force, run-up angle, and level of inundation in connection with the parcel or lot upon which the proposed development is to be located.

This report is prepared by David Skelly, a California licenced professional engineer specializing in coastal engineering. I have over 37 years experience in coastal engineering. Prior to joining the GSI team, I worked as a research engineer at the Center for Coastal Studies at Scripps Institution of Oceanography for 17 years. During my tenure at Scripps, I worked on coastal erosion problems throughout the world. I have written numerous technical reports and published papers on these projects. I have performed numerous wave runup analysis for coastal development, including analyzing coastal processes, wave forces, water elevation, longshore transport of sand, and coastal erosion. I have extensive experience in producing environmental documentation concerning coastal projects on the federal, state, and local level. I am recognized by the California Coastal Commission as professionally capable of producing this type of tsunami runup analysis. I am a founding member of the Association of Coastal Engineers.

Does the report provide estimates, based on credible and listed sources, of the following, in connection with the parcel or lot upon which the proposed development is to be located: a) probable maximum wave height, b) wave force, c) run-up angle, and d) level of inundation?

Yes. The maximum tsunami bore height at the site will be less than 1 foot. The force will be minimal. Provided that the finished first floor is 1 foot or greater above adjacent grade there will be no inundation of the structure.

How do a) through d) of the question above change with anticipated rises in sea level?

The analysis herein used 3.5 feet of sea level rise over the next 75 years. This is in the upper range recommended by the CCC.

2. No structure covered by this section shall be allowed within that portion of the lot or parcel where the projected wave height and force is fifty (50) percent or more of the projected maximum, unless: (a) the highest projected wave height above ground level at

the location of the structure is less than six (6) feet, (b) no residential floor level is less than two (2) feet above that wave height, and (c) the structural support is sufficient to withstand the projected wave force.

No portion of the site will be subject to bore height or forces that are greater than about 15% of the design tsunami height (6.5 feet) and resulting force. The wave force is proportional to the square of the velocity. Therefore, a 6-foot tsunami will have 36 times the force of a 1 foot tsunami bore.

Are residential structure(s) proposed within that portion of the lot or parcel where the projected wave height and force is fifty (50) percent or more of the projected maximum?

No.

With anticipated rise in sea level factored in, would the project comply with the question above?

The analysis herein accounted for 3.5 feet of sea level rise over the next 75 years. This is based upon the latest published SLR predictions. It should be noted that an increase of sea level as much as 4 feet over the next 75 years will not change the level of inundation at the site. The site is reasonably safe from tsunamis due to the breakwater, the 3000 feet set back from the breakwater, and elevation above the potential flood levels. The natural grade at the base of the structures is ~9 feet NGVD29. The first floor height is ~11 feet NGVD29.

3. No structure covered by this section shall be allowed within that portion of the lot or parcel where the projected wave height and force is less than fifty (50) percent of the projected maximum unless the requirements of subsection b, 2), (a), and (c) are satisfied and the residential flood level is at least one (1) foot above the highest projected level of inundation.

Not applicable.

Are residential structure(s) proposed within that portion of the lot or parcel where the projected wave height and force is less than fifty (50) percent of the projected maximum?

No.

4. Permission under this subsection shall not be granted if the Planning Commission determines that sufficient data, upon which the report required by subsection 1) must be based, is unavailable and cannot feasibly be developed by the applicant.

Is the report required by subsection 1) based on sufficient data? If not, is the information available or can the preparer feasibly develop the sufficient data?

It is GSI opinion that the the analysis herein meets the standard of practice for coastal engineering and accurately describes the potential tsunami hazard at the site.

CONCLUSIONS AND RECOMMENDATIONS

The proposed project is reasonably safe from tsunami hazards due to its elevation and location relative to the shoreline. In addition, the breakwater provides a significant structural barrier to tsunami propagation onto the sites. The tsunami wave will break on the breakwater and possibly overtop the structure. It will then propagate across the open water of the protected bay to the shoreline. Upon reaching the shoreline, the tsunami bore will runup as the grade elevation increases. If it reaches the site the bore will be less than 1 foot in height with no significant force. The proposed finished floors are reasonably safe from tsunami inundation due to their elevation above finished grade.

In closing, there is no significant tsunami hazard at the proposed project. No recommendations are necessary to mitigate the less than significant hazard from an extreme tsunami to the development. However, because there will be many hours of warning prior to the arrival of a tsunami, the applicant should be aware of the tsunami evacuation routes in the area.

Should have any questions, please do not hesitate to contact the undersigned at (760) 438-3155.

Sincerely,

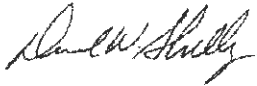

GeoSoils, Inc.
David W. Skelly MS, PE



ADDITIONAL REFERENCES

Cayan, Daniel R., Bromirski, Peter, D., Hayhoe, Katharine, Tyree, Mary, Dettinger, Michael D., and Flick, Reinhard E., 2008, "Climate change projections of sea level extremes along the California coast," *Climate Change* 2008.

Coastal Engineering Manual 2004, US Army Engineer Waterways Experiment Station, Coastal Engineering Research Center, US Government Printing Office, Washington, DC.

Everest International Consultants, Inc., 2011, Assessment of seawall structure integrity and potential for seawall over-topping for Balboa Island and Little Balboa Island, main report, No Project No., dated April 21.

FEMA, 2014, Guidelines and Specifications for Flood Hazard Mapping Partners.

FEMA Website <http://msc.fema.gov/>

Lander, James F., P. Lockridge, and M. Kozuch, 1993, "Tsunamis Affecting the West Coast of the US, 1806-1992," NOAA National Geophysical Data Center publication.

Legg, Mark R. and Borrero, Jose C., Tsunami potential of major restraining bends along submarine strike-slip faults, *in* ITS 2001 Proceedings, Session 1, Number 1-9.

Legg, Mark R., Borrero, Jose C., and Synolakis, Costas E., Evaluation of tsunami risk to southern California coastal cities, *in* The 2002 NEHRP Professional Fellowship Report.

Rivero, Carlos, Shaw, John H., and Mueller, Karl, Oceanside and Thirtymile Bank blind thrusts: Implications for earthquake hazards *in* coastal southern California, in *Geology*, October 2000 edition, v. 28, no. 10, p. 891-894, 5 figures.

Shore Protection Manual, 1984, 4th ed. 2 Vols, US Army Engineer Waterways Experiment Station, Coastal Engineering Research Center, US Government Printing Office, Washington, DC.

"Tsunami Alert and Excavation Plan On the San Mateo County Coast," Grand Jury County of San Mateo, 2006.

ATTACHMENT D

**PRELIMINARY DELINEATION OF WETLANDS
UNDER SECTION 404 OF THE CLEAN WATER ACT AND
CALIFORNIA COASTAL ACT/
SAN MATEO COUNTY LOCAL COASTAL PROGRAM**

115 WEST POINT AVENUE
EL GRANADA, SAN MATEO COUNTY, CALIFORNIA

DECEMBER 2013

Prepared for:

Mike Paravati
Paravati Construction Inc.
945 Durlston Rd.
Redwood City CA 94062

Prepared by:

Tom Mahony, Principal/Plant Ecologist
Coast Range Biological, LLC
PO Box 1238
Santa Cruz, CA 95061
(831) 426-6226
coastrange@sbcglobal.net



RECEIVED

APR 23 2014

San Mateo County
Planning and Building Department

PLN 2014-00133

TABLE OF CONTENTS

1.0 INTRODUCTION	1
2.0 METHODS	1
2.1 Hydrophytic Vegetation	3
2.2 Wetland Hydrology	4
2.3 Hydric Soils	4
2.4 Other Waters of the U.S.	4
3.0 LIMITATIONS.....	4
4.0 PROJECT SITE AND STUDY AREA DESCRIPTION	5
4.1 Vegetation.....	5
4.2 Hydrology.....	5
4.3 Soils	6
5.0 RESULTS AND CONCLUSIONS	6
6.0 REFERENCES	7

LIST OF FIGURES

Figure 1. Study Area Location Map.	2
---	---

LIST OF TABLES

Table 1. Wetland Plant Indicator Status.	3
---	---

APPENDICES

- Appendix A. Corps Delineation Data Forms
- Appendix B. Preliminary Delineation Map of the Study Area
- Appendix C. Study Area Photos

1.0 INTRODUCTION

At the request of Paravati Construction Inc., Coast Range Biological LLC conducted a preliminary delineation to determine the location and extent of waters, including wetlands, potentially subject to jurisdiction by the U.S. Army Corps of Engineers (Corps) under Section 404 of the Clean Water Act (CWA), and by the California Coastal Commission (CCC)/County of San Mateo under the California Coastal Act (CCA)/San Mateo County Local Coastal Program (LCP) at 115 West Point Avenue in El Granada in unincorporated San Mateo County, California ("project site") (Figure 1). The proposed project involves construction of a garage, upstairs office, and storage building northwest of an existing residence, as shown on project plans prepared by McGriff Architects. The "study area" for this delineation includes the project site and adjacent areas extending ~100-feet around the project site. Due to a lack of access on adjacent private property, areas outside the project site were assessed by an analysis of background materials along with a visual reconnaissance from the project site and other publicly accessible areas. A particular focus of the delineation was determining the location of the Pillar Point Marsh boundary in relation to the project site.

The CWA gives the Corps and Environmental Protection Agency (EPA) jurisdiction over "waters of the United States" which include lakes, rivers, streams (including intermittent or ephemeral streams) and wetlands. "Wetlands" are jointly defined by the Corps and EPA as:

"Those areas that are inundated or saturated by surface or ground water at a frequency and duration sufficient to support, and that under normal circumstances do support, a prevalence of vegetation typically adapted for life in saturated soil conditions. Wetlands generally include swamps, marshes, bogs, and similar areas" (Federal Register 1980; Federal Register 1982).

Wetlands are defined in the LCP as:

"An area where the water table is at, near, or above the land surface long enough to bring about the formation of hydric soils or to support the growth of plants which normally are found to grow in water or wet ground. Such wetlands can include mudflats (barren of vegetation), marshes, and swamps. Such wetlands can be either fresh or saltwater, along streams (riparian), in tidally influenced areas (near the ocean and usually below extreme high water of spring tides), marginal to lakes, ponds, and man-made impoundments. Wetlands do not include areas which in normal rainfall years are permanently submerged (streams, lakes, ponds and impoundments), nor marine or estuarine areas below extreme low water of spring tides, nor vernal wet areas where the soils are not hydric."

2.0 METHODS

Prior to the field delineation, available reference materials were reviewed, including the Soil Survey of San Mateo County (NRCS 2013), National Wetlands Inventory maps (USFWS 2013), topographic maps (USGS 1956), aerial photographs, and the San Mateo County LCP. A routine-level jurisdictional delineation was conducted on December 19, 2013. The project site was field-checked for indicators of hydrophytic vegetation, wetland hydrology, and hydric soils. Sample points were taken on the project site and recorded on Corps data forms provided in the *Regional Supplement to the Corps of Engineers Wetland Delineation Manual: Arid West Region (Version 2.0)* ("Arid West Supplement")

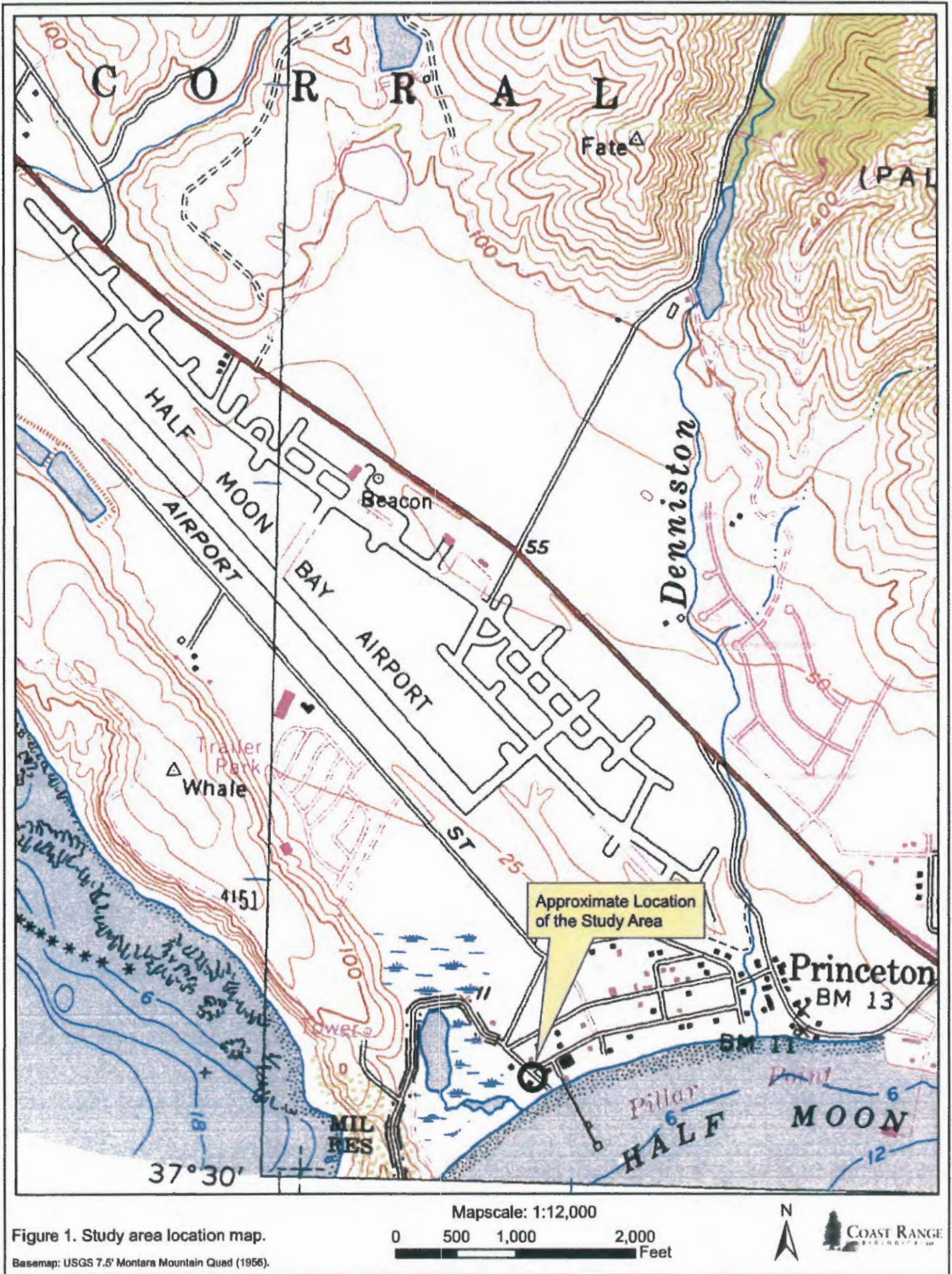

Figure 1. Study area location map.

Basemap: USGS 7.5' Montara Mountain Quad (1956).

Mapscale: 1:12,000

0 500 1,000 2,000
Feet



COAST RANGE
ENGINEERS & ARCHITECTS

(USACE 2008)¹. Data forms are presented in Appendix A. The adjacent study area, where access was unavailable due to private property constraints, was visually assessed from the project site and surrounding publicly accessible areas in conjunction with a detailed review of aerial photographs, Soil Survey data (NRCS 2013), National Wetlands Inventory maps (USFWS 2013), topographic maps (USGS 1956), and the San Mateo County LCP.

This wetland delineation and preliminary jurisdictional determination followed guidelines provided in the Arid West Supplement and the *Corps of Engineers Wetlands Delineation Manual* (“Corps Manual”) (Environmental Laboratory 1987). In addition, areas that could meet the CCA/LCP wetland definition were also evaluated (e.g., the “one-parameter approach”, where the presence of any one indicator—hydrophytic vegetation, wetland hydrology, or hydric soils—is generally sufficient to delineate an area as wetland under the CCA/LCP). Based on the presence or absence of field indicators—including vegetation, hydrology and soils—the limits of potential jurisdictional wetlands and other waters of the U.S. and CCA/LCP were determined. Study area features were mapped on a 2010 digital orthophoto using ArcGIS mapping software (Appendix B).

2.1 Hydrophytic Vegetation

Hydrophytic vegetation is defined as “the sum total of macrophytic plant life that occurs in areas where the frequency and duration of inundation or soil saturation produce permanently or periodically saturated soils of sufficient duration to exert a controlling influence on the plant species present” (Environmental Laboratory 1987). In order to determine if hydrophytic vegetation is present, each plant species occurring in a sample plot is identified and assigned a wetland indicator status (Table 1) based on the *National Wetland Plant List* (Lichvar 2013).

Table 1. Wetland Plant Indicator Status.

Indicator Status Rating	Designation	Qualitative Description (Lichvar 2013)
Obligate (OBL)	Hydrophyte	Almost always occur in wetlands
Facultative Wetland (FACW)	Hydrophyte	Usually occur in wetlands, but may occur in non-wetlands
Facultative (FAC)	Hydrophyte	Occur in wetlands and non-wetlands
Facultative Upland (FACU)	Nonhydrophyte	Usually occur in non-wetlands, but may occur in wetlands
Upland (UPL)	Nonhydrophyte	Almost never occur in wetlands

Plants that have an indicator status of OBL, FACW, and FAC are considered to be typically adapted for life in anaerobic soils conditions, and qualify as hydrophytic species for Section 404 delineations. If more than 50 percent of the dominant plant species present in a sample plot are classified as hydrophytic species (e.g., FAC or wetter), the area has met the hydrophytic vegetation criterion. Dominant species are selected using the “50/20 rule” (USACE 2008).

¹ The Arid West Supplement was chosen for the delineation rather than the Western Mountains, Valleys, and Coast Region Supplement because the study area’s habitat and climatic conditions are more typical of San Francisco Bay Area conditions where the Arid West Supplement is used. As stated in the Arid West Supplement: “The decision to use the Western Mountains, Valleys, and Coast Regional Supplement or the Arid West Regional Supplement on a particular field site should be based on landscape and site conditions, and not solely on map location.”

2.2 Wetland Hydrology

Wetland hydrology “encompasses all hydrologic characteristics of areas that are periodically inundated or have soils saturated to the surface at some time during the growing season sufficient to create anaerobic and reducing conditions” (Environmental Laboratory 1987). The jurisdictional wetland hydrology criterion is satisfied if the area is inundated or saturated to the surface for a minimum of five percent of the growing season. If recorded data, such as stream or tidal gauge data, are lacking, field indicators are used to determine the presence of wetland hydrology. Field indicators include primary indicators, such as observed inundation or saturation, biotic crust, and oxidized rhizospheres on living roots; or secondary indicators, such as drainage patterns and FAC-neutral test. The presence of one primary indicator, or two secondary indicators, is sufficient to conclude that an area has wetland hydrology (USACE 2008).

2.3 Hydric Soils

Hydric soils are defined by the Natural Resources Conservation Service as “soils that formed under conditions of saturation, flooding, or ponding long enough during the growing season to develop anaerobic conditions in the upper part of the soil” (Federal Register 1994). Nearly all hydric soils exhibit characteristic morphologies that result from repeated periods of saturation or inundation, or both, for more than a few days. Characteristic hydric soil indicators observable in the field include: histic epipedons; sulfidic material; aquic or preaquic moisture regime; reducing conditions; iron and manganese concretions; and soil colors (gleyed soils, soils with mottles and/or low chroma matrix). Color designations are determined by comparing a soil sample with a standard Munsell soil color chart (Gretag Macbeth 2000). The presence of any one of the above listed field indicators is considered sufficient to meet the hydric soil criterion.

2.4 Other Waters of the U.S.

In addition to potential jurisdictional wetlands, this study evaluated the presence of any waters of the U.S. and/or State of California other than wetlands potentially subject to jurisdiction under Section 404 of CWA and/or the CCA/LCP. “Other waters” are seasonal or perennial water bodies, such as lakes, stream channels (including intermittent or ephemeral streams), drainages, ponds, and other surface water features that exhibit an Ordinary High Water Mark (OHWM) but lack positive indicators of one or more of the three wetland parameters (hydrophytic vegetation, wetland hydrology, hydric soils) (Federal Register 1986). In non-tidal “other waters,” Corps jurisdiction extends to the OHWM, defined as “that line on the shore established by the fluctuations of water and indicated by physical characteristics such as clear, natural line impressions on the bank, shelving, changes in the characteristics of the soil, destruction of terrestrial vegetation, the presence of litter and debris, or other appropriate means that consider the characteristics of the surrounding areas” (Federal Register 1986; USACE 2005).

3.0 LIMITATIONS

This is a preliminary delineation based on the aforementioned methods, conditions observed at the time of the field survey, the biologist’s interpretation of those conditions, and best professional judgment. Expert opinion may differ. The regulatory agencies make the final determination on the presence or absence of wetlands or other waters on a project site, and a delineation is not final unless verified by these agencies. The delineation was conducted at a time of year when seasonal hydrology was lacking and plant identification difficult due to senescence of herbaceous species from the

previous growing season and recent germination of grasses and forbs after fall rains. Plants that are dominant at the time of this survey may shift in importance depending on rainfall conditions and the season of the survey, or population shifts over time. Areas outside the project site were not surveyed on foot due to private property constraints. These areas were assessed from publicly accessible areas and a review of background materials.

4.0 PROJECT SITE AND STUDY AREA DESCRIPTION

The project site covers ~4,150 ft² (0.095-acre) and occurs at 115 West Point Avenue in El Granada in unincorporated San Mateo County (Figure 1). The study area covers ~1.4-acres and includes the project site and adjacent areas extending outward 100 feet. The project site and study area occur at ~10 feet elevation and are generally level or sloping gradually toward the southwest (USGS 1956). The project site is heavily disturbed by past and ongoing activity associated with the adjacent residence, and is used primarily as a parking and storage area for vehicles, shipping containers, and other debris (Appendix C). The surrounding study area consists of commercial development to the north and east and undeveloped land associated with Pillar Point Marsh and Pillar Point Harbor to the west and south, respectively.

4.1 Vegetation

Four habitats are present on the study area: Ruderal, Developed, Iceplant-Dune, and Poison Hemlock (Appendix B). Ruderal habitat covers the project site and consists of highly disturbed areas dominated by non-native grasses and forbs including soft chess (*Bromus hordeaceus*², FACU), sweet alyssum (*Lobularia maritima*, UPL), Italian ryegrass (*Festuca perennis*, FAC), wild oats (*Avena* sp., UPL), ripgut brome (*Bromus diandrus*, UPL), cheeseweed (*Malva parviflora*, UPL), wild radish (*Raphanus sativus*, UPL), and Bermuda buttercup (*Oxalis pes-caprae*, UPL), along with patches of saltgrass (*Distichlis spicata*, FAC) in sandy areas and planted Monterey cypress (*Hesperocyparis macrocarpa*, UPL) southeast of the house. Developed habitat consists of residential and commercial development, along with associated infrastructure and landscaping, and occurs adjacent to the project site around the existing residence, and north and east of the project site in areas of commercial development. Iceplant-Dune habitat occurs in southwestern portions of the study area in remnant sand dunes, and is dominated by a dense cover of non-native iceplant (*Carpobrotus edulis*, UPL), along with occasional native dune species such as saltgrass, beach strawberry (*Fragaria chiloensis*, UPL), and American dunegrass (*Elymus mollis*, FACU). Poison Hemlock consists of dense areas of poison hemlock (*Conium maculatum*, FACW), wild radish (UPL), bull thistle (*Cirsium vulgare*, FACU), and other species that were not identifiable due to lack of site access.

4.2 Hydrology

The principal hydrologic sources for the project site are direct precipitation and surface sheet flow from surrounding uplands. No drainage channels or ponds were observed on or adjacent to the project site. No streams have been mapped on the project site or surrounding study area (USGS 1956; USFWS 2013). Pillar Point Marsh occurs ~125-feet southwest of the project site, and Pillar Point Harbor occurs ~200-feet southeast of the project site. The study area was dry at the time of the December 19, 2013 field visit.

² Botanical nomenclature follows Baldwin et al. (2012).

4.3 Soils

One soil type has been mapped for the study area (NRCS 2013): Denison clay loam, nearly level. This moderately well-drained soil is derived from alluvium, and is typically found on terraces and toeslopes. A typical profile consists of clay loam in the upper 10 inches of soil profile, clay from 10 to 45 inches, clay loam from 45 to 61 inches, and loam from 61 to 70 inches. The depth to a restrictive feature is typically greater than 80 inches. Soils on most of the study area are heavily disturbed by past land use, and contain areas of non-native gravel as well as sandy areas, and generally did not match the mapped type.

5.0 RESULTS AND CONCLUSIONS

Pillar Point Marsh

Based on a review of background materials and a visual reconnaissance of vegetation, hydrology, and topography, the Pillar Point Marsh boundary occurs ~125-feet southwest of the project site (Appendix B). Previous mapping (USGS 1956; USFWS 2013; LCP Map 7.1) located the marsh boundary southwest of the project site, and this was confirmed during the field reconnaissance. The marsh is dominated by open water and mudflat in the vicinity of the study area, with fringing wetland species such as pickleweed (*Salicornia pacifica*, OBL) and saltgrass (FAC) near the upland edge. Unvegetated coastal strand habitat occurs east and south of the marsh boundary where it enters Pillar Point Harbor, and the marsh boundary in this area is expected to shift frequently based on rainfall and tidal action. North and northeast of the marsh boundary, at higher elevations, dense areas of iceplant (UPL) are present on and adjacent to remnant sand dunes, along with scattered native dune species such as saltgrass, American dune grass (FACU), beach strawberry (UPL), and gumplant (*Grindelia* sp.). In disturbed areas north and east of the Iceplant-Dune habitat, dense non-native herbaceous vegetation is present, dominated by poison hemlock (FACW), along with wild radish (UPL), bull thistle (FACU), and other species that were not identifiable due to a lack of site access. Though poison hemlock is wetland-classified, this area is at a higher elevation than the marsh and separated from it by upland sand dunes, with no other hydrologic sources observed. Poison hemlock is disturbance-adapted and tends to occur on berms and other disturbed upland locations with moist soils (Bossard et al. 2000; Baldwin et al. 2012; personal observation), which frequently occur in the Coastal Zone due to fog drip and reduced evaporative stress during the dry season from coastal stratus.

Pillar Point Marsh would qualify as a wetland by the Corps and the CCA/LCP. Wetland buffer zones are outlined in Section 7.18 of the LCP: *"Buffer zones shall extend a minimum of 100 feet landward from the outermost line of wetland vegetation. This setback may be reduced to no less than 50 feet only where: (1) no alternative development site or design is possible; and (2) adequacy of the alternative setback to protect wetland resources is conclusively demonstrated by a professional biologist to the satisfaction of the County and the State Department of Fish and Game. A larger setback shall be required as necessary to maintain the functional capacity of the wetland ecosystem."*

Based on the delineation described above, the project site falls outside the Pillar Point Marsh 100-foot buffer zone (Appendix B).

Project Site

Three sample points were taken on and adjacent to the project site where access was available (Appendix A), and indicators of the three wetland parameters were generally not observed³. The

³ See Section 3.0 for limitations associated with the delineation.

project site is highly disturbed and dominated by Ruderal habitat. No surface water, soil saturation, or other indicators of wetland hydrology were observed on or adjacent to the project site, (though the field visit occurred prior to the onset of substantial rainfall typical of the late fall and winter).

Vegetation on the project site was difficult to identify due to extensive disturbance and the season in which the work was conducted (senescence of herbaceous species from the previous growing season and recent germination of grasses and forbs after initial fall rains). Based on identifiable species, the project site is dominated by a mixture of upland or facultative upland grasses and forbs, such as soft chess (FACU), sweet alyssum (UPL), cheeseweed (UPL), wild radish (UPL), and red filaree (*Erodium cicutarium*, UPL), along with areas of FAC-classified species including Italian ryegrass and saltgrass (Appendix A). Saltgrass may be responding to sandy soils rather than wetland hydrology, as the species was observed on nearby upland dunes and adjacent roadside areas. Species composition is anticipated to change as vegetation matures throughout the growing season.

Soils on the project site were heavily disturbed by gravel and compaction from ongoing land use, and generally consisted of 10YR 3/2 loam in the upper 4 inches of soil profile and 10YR 4/4 or 4/3 loamy sand from 4 to 20 inches (Appendix A). Some areas had a clay layer >12 inches deep that contained redoximorphic mottles, but this layer generally occurred beneath the plant rooting zone, and therefore did not meet hydric soil indicators (USACE 2008).

6.0 REFERENCES

- Baldwin, B.G., D.H. Goldman, D.J. Keil, R. Patterson, T.J. Rosatti, and D.H. Wilken, editors. 2012. The Jepson manual: vascular plants of California, second edition. University of California Press, Berkeley.
- Bossard, C.C., J.M. Randall, and M.C. Hoshovsky. 2000. Invasive plants of California's wildlands. University of California Press, Berkeley, CA.
- Environmental Laboratory. 1987. Corps of Engineers wetlands delineation manual. Technical report Y-87-1, U.S. Army Corps of Engineers Waterways Experiment Station, Vicksburg, Mississippi.
- Federal Register. 1980. Environmental Protection Agency, 40 CFR Part 230: Section 404(b)(1) guidelines for specification of disposal sites for dredged or fill material.
- Federal Register. 1982. Department of the Army, Corps of Engineers, Title 33: Navigation and navigable waters; Chapter 2. Regulatory program, Corps of Engineers.
- Federal Register. 1986. Department of the Army, Corps of Engineers, 33 CFR Parts 320 through 330, Regulatory Programs of the Corps of Engineers; Final Rule. Vol. 51, No. 219; page 41217, November 13.
- Federal Register. 1994. Changes in hydric soils of the United States. Washington, DC, July 13.
- Gretag Macbeth. 2000. Munsell soil color charts. New Windsor, New York.
- Lichvar, R.W. 2013. The National Wetland Plant List: 2013 wetland ratings. Phytoneuron 2013-49: 1-241.
- Natural Resource Conservation Service. 2013. Web Soil Survey for San Mateo County, CA. Accessed at: <http://websoilsurvey.nrcs.usda.gov/app/WebSoilSurvey.aspx>.

U.S. Army Corps of Engineers. 2005. Regulatory Guidance Letter: Ordinary High Water Mark Identification. December 5.

U.S. Army Corps of Engineers. 2008. Regional Supplement to the Corps of Engineers Wetland Delineation Manual: Arid West Region (Version 2.0), ed. J. S. Wakeley, R. W. Lichvar, and C. V. Noble. ERDC/EL TR-08-28. Vicksburg, MS: U.S. Army Engineer Research and Development Center.

U.S. Fish and Wildlife Service. 2013. National Wetlands Inventory. Accessed at <http://www.fws.gov/wetlands>.

U.S. Geological Survey. 1956. Montara Mountain, CA 7.5 minute topographic quadrangle.

APPENDIX A

CORPS DELINEATION DATA FORMS

WETLAND DETERMINATION DATA FORM – Arid West Region

Project/Site: 115 West Point Avenue City/County: El Granada/San Mateo County Sampling Date: 12/19/13
 Applicant/Owner: Reza Malek State: CA Sampling Point: 1
 Investigator(s): Coast Range Biological, LLC Section, Township, Range: T5S,R6W,sec14
 Landform (hillslope, terrace, etc.): vacant lot Local relief (concave, convex, none): hummocky Slope (%): 0
 Subregion (LRR): LRR-A Lat: 37.502307 Long: -122.493464 Datum: WGS84
 Soil Map Unit Name: Denison clay loam, nearly level NWI classification: Upland

Are climatic / hydrologic conditions on the site typical for this time of year? Yes No (If no, explain in Remarks.)
 Are Vegetation , Soil , or Hydrology significantly disturbed? Are "Normal Circumstances" present? Yes No
 Are Vegetation , Soil , or Hydrology naturally problematic? (If needed, explain any answers in Remarks.)

SUMMARY OF FINDINGS – Attach site map showing sampling point locations, transects, important features, etc.

Hydrophytic Vegetation Present? Yes <input type="checkbox"/> No <input checked="" type="checkbox"/> Hydric Soil Present? Yes <input type="checkbox"/> No <input checked="" type="checkbox"/> Wetland Hydrology Present? Yes <input type="checkbox"/> No <input checked="" type="checkbox"/>	Is the Sampled Area within a Wetland? Yes <input type="checkbox"/> No <input checked="" type="checkbox"/>
Remarks: Located on hummocky area next to house. Highly disturbed.	

VEGETATION – Use scientific names of plants.

Tree Stratum (Plot size: _____)	Absolute % Cover	Dominant Species?	Indicator Status	Dominance Test worksheet:
1. _____	_____	_____	_____	Number of Dominant Species That Are OBL, FACW, or FAC: <u>2</u> (A)
2. _____	_____	_____	_____	Total Number of Dominant Species Across All Strata: <u>4</u> (B)
3. _____	_____	_____	_____	Percent of Dominant Species That Are OBL, FACW, or FAC: <u>50</u> (A/B)
4. _____	_____	_____	_____	
_____ = Total Cover				
Sapling/Shrub Stratum (Plot size: _____)				Prevalence Index worksheet:
1. _____				<u>Total % Cover of:</u> _____ <u>Multiply by:</u> _____
2. _____				OBL species _____ x 1 = _____
3. _____				FACW species _____ x 2 = _____
4. _____				FAC species <u>40</u> x 3 = <u>120</u>
5. _____				FACU species <u>20</u> x 4 = <u>80</u>
_____ = Total Cover				UPL species <u>30</u> x 5 = <u>150</u>
				Column Totals: <u>90</u> (A) <u>350</u> (B)
				Prevalence Index = B/A = <u>3.88</u>
Herb Stratum (Plot size: <u>5' radius</u>)				Hydrophytic Vegetation Indicators:
1. <u>Lobularia maritima</u>	<u>20</u>	<u>Y</u>	<u>UPL</u>	<input type="checkbox"/> Dominance Test is >50%
2. <u>Distichlis spicata</u>	<u>20</u>	<u>Y</u>	<u>FAC</u>	<input type="checkbox"/> Prevalence Index is ≤3.0 ¹
3. <u>Bromus hordeaceus (?)</u>	<u>20</u>	<u>Y</u>	<u>FACU</u>	<input type="checkbox"/> Morphological Adaptations ¹ (Provide supporting data in Remarks or on a separate sheet)
4. <u>Festuca perennis (?)</u>	<u>20</u>	<u>Y</u>	<u>FAC</u>	<input type="checkbox"/> Problematic Hydrophytic Vegetation ¹ (Explain)
5. <u>Malva parviflora</u>	<u>5</u>	<u>N</u>	<u>UPL</u>	
6. <u>Erodium cicutarium</u>	<u>5</u>	<u>N</u>	<u>UPL</u>	
7. <u>Unknown grass/forb seedlings</u>	<u>5</u>	<u>N</u>		
8. _____				
_____ = Total Cover				
Woody Vine Stratum (Plot size: _____)				
1. _____				
2. _____				
_____ = Total Cover				
% Bare Ground in Herb Stratum <u>5</u> % Cover of Biotic Crust <u>0</u>				
				Hydrophytic Vegetation Present? Yes <input type="checkbox"/> No <input checked="" type="checkbox"/>
Remarks: Sample point not dominated by hydrophytic vegetation, but plant ID extremely difficult due to disturbance and season. Abundant seedlings not identifiable, best professional judgment used. Dominance could change based on season. Distichlis appears most dominant in sandy soils, and is possibly responding to sandy substrate rather than hydrology.				

SOIL

Sampling Point: 1

Profile Description: (Describe to the depth needed to document the indicator or confirm the absence of indicators.)								
Depth (inches)	Matrix		Redox Features				Texture	Remarks
	Color (moist)	%	Color (moist)	%	Type ¹	Loc ²		
0-4	10YR 3/2	100					sndy loam	
4-12	10YR 4/4	100					loamy snd	
12-20	10YR 4/3	100					loamy snd	
¹ Type: C=Concentration, D=Depletion, RM=Reduced Matrix, CS=Covered or Coated Sand Grains. ² Location: PL=Pore Lining, M=Matrix.								
Hydric Soil Indicators: (Applicable to all LRRs, unless otherwise noted.)						Indicators for Problematic Hydric Soils ³ :		
<input type="checkbox"/> Histosol (A1)			<input type="checkbox"/> Sandy Redox (S5)			<input type="checkbox"/> 1 cm Muck (A9) (LRR C)		
<input type="checkbox"/> Histic Epipedon (A2)			<input type="checkbox"/> Stripped Matrix (S6)			<input type="checkbox"/> 2 cm Muck (A10) (LRR B)		
<input type="checkbox"/> Black Histic (A3)			<input type="checkbox"/> Loamy Mucky Mineral (F1)			<input type="checkbox"/> Reduced Vertic (F18)		
<input type="checkbox"/> Hydrogen Sulfida (A4)			<input type="checkbox"/> Loamy Gleyed Matrix (F2)			<input type="checkbox"/> Red Parent Material (TF2)		
<input type="checkbox"/> Stratified Layers (A5) (LRR C)			<input type="checkbox"/> Depleted Matrix (F3)			<input type="checkbox"/> Other (Explain in Remarks)		
<input type="checkbox"/> 1 cm Muck (A9) (LRR D)			<input type="checkbox"/> Redox Dark Surface (F6)					
<input type="checkbox"/> Depleted Below Dark Surface (A11)			<input type="checkbox"/> Depleted Dark Surface (F7)					
<input type="checkbox"/> Thick Dark Surface (A12)			<input type="checkbox"/> Redox Depressions (F8)					
<input type="checkbox"/> Sandy Mucky Mineral (S1)			<input type="checkbox"/> Vernal Pools (F9)					
<input type="checkbox"/> Sandy Gleyed Matrix (S4)								
Restrictive Layer (if present):								
Type: <u>none</u>								
Depth (inches): _____						Hydric Soil Present? Yes _____ No <input checked="" type="checkbox"/>		
Remarks:								
Soils highly disturbed. Do not match mapped type. Non-native fill present.								

HYDROLOGY

Wetland Hydrology Indicators:		
Primary Indicators (minimum of one required; check all that apply)	Secondary Indicators (2 or more required)	
<input type="checkbox"/> Surface Water (A1)	<input type="checkbox"/> Salt Crust (B11)	<input type="checkbox"/> Water Marks (B1) (Riverine)
<input type="checkbox"/> High Water Table (A2)	<input type="checkbox"/> Biotic Crust (B12)	<input type="checkbox"/> Sediment Deposits (B2) (Riverine)
<input type="checkbox"/> Saturation (A3)	<input type="checkbox"/> Aquatic Invertebrates (B13)	<input type="checkbox"/> Drift Deposits (B3) (Riverine)
<input type="checkbox"/> Water Marks (B1) (Nonriverine)	<input type="checkbox"/> Hydrogen Sulfide Odor (C1)	<input type="checkbox"/> Drainage Patterns (B10)
<input type="checkbox"/> Sediment Deposits (B2) (Nonriverine)	<input type="checkbox"/> Oxidized Rhizospheres along Living Roots (C3)	<input type="checkbox"/> Dry-Season Water Table (C2)
<input type="checkbox"/> Drift Deposits (B3) (Nonriverine)	<input type="checkbox"/> Presence of Reduced Iron (C4)	<input type="checkbox"/> Crayfish Burrows (C8)
<input type="checkbox"/> Surface Soil Cracks (B6)	<input type="checkbox"/> Recent Iron Reduction in Tilled Soils (C6)	<input type="checkbox"/> Saturation Visible on Aerial Imagery (C9)
<input type="checkbox"/> Inundation Visible on Aerial Imagery (B7)	<input type="checkbox"/> Thin Muck Surface (C7)	<input type="checkbox"/> Shallow Aquitard (D3)
<input type="checkbox"/> Water-Stained Leaves (B9)	<input type="checkbox"/> Other (Explain in Remarks)	<input type="checkbox"/> FAC-Neutral Test (D5)
Field Observations:		
Surface Water Present? Yes _____ No <input checked="" type="checkbox"/>	Depth (inches): <u>none</u>	Wetland Hydrology Present? Yes _____ No <input checked="" type="checkbox"/>
Water Table Present? Yes _____ No <input checked="" type="checkbox"/>	Depth (inches): <u>none</u>	
Saturation Present? (includes capillary fringe) Yes _____ No <input checked="" type="checkbox"/>	Depth (inches): <u>none</u>	
Describe Recorded Data (stream gauge, monitoring well, aerial photos, previous inspections), if available:		
<u>None</u>		
Remarks:		
Soils dry. No wetland hydrology indicators observed.		

WETLAND DETERMINATION DATA FORM – Arid West Region

Project/Site: 115 West Point Avenue City/County: El Granada/San Mateo County Sampling Date: 12/19/13
 Applicant/Owner: Reza Malek State: CA Sampling Point: 2
 Investigator(s): Coast Range Biological, LLC Section, Township, Range: T5S,R6W,sec14
 Landform (hillslope, terrace, etc.): vacant lot/hummocky Local relief (concave, convex, none): concave Slope (%): 5
 Subregion (LRR): LRR-A Lat: 37.502366 Long: -122.493441 Datum: WGS84
 Soil Map Unit Name: Denison clay loam, nearly level NWI classification: Upland

Are climatic / hydrologic conditions on the site typical for this time of year? Yes No (If no, explain in Remarks.)
 Are Vegetation , Soil , or Hydrology significantly disturbed? Are "Normal Circumstances" present? Yes No
 Are Vegetation , Soil , or Hydrology naturally problematic? (If needed, explain any answers in Remarks.)

SUMMARY OF FINDINGS – Attach site map showing sampling point locations, transects, important features, etc.

Hydrophytic Vegetation Present? Yes <input type="checkbox"/> No <input checked="" type="checkbox"/>	Is the Sampled Area within a Wetland? Yes <input type="checkbox"/> No <input checked="" type="checkbox"/>
Hydric Soil Present? Yes <input type="checkbox"/> No <input checked="" type="checkbox"/>	
Wetland Hydrology Present? Yes <input type="checkbox"/> No <input checked="" type="checkbox"/>	

Remarks:
 Located on hummocky area next to house. Highly disturbed.

VEGETATION – Use scientific names of plants.

Tree Stratum (Plot size: _____)	Absolute % Cover	Dominant Species?	Indicator Status	Dominance Test worksheet: Number of Dominant Species That Are OBL, FACW, or FAC: <u>2</u> (A) Total Number of Dominant Species Across All Strata: <u>4</u> (B) Percent of Dominant Species That Are OBL, FACW, or FAC: <u>50</u> (A/B)
1. _____	_____	_____	_____	
2. _____	_____	_____	_____	
3. _____	_____	_____	_____	
4. _____	_____	_____	_____	
_____ = Total Cover				Prevalence Index worksheet: Total % Cover of: _____ Multiply by: OBL species _____ x 1 = _____ FACW species _____ x 2 = _____ FAC species <u>30</u> x 3 = <u>90</u> FACU species <u>15</u> x 4 = <u>60</u> UPL species <u>25</u> x 5 = <u>125</u> Column Totals: <u>70</u> (A) <u>275</u> (B) Prevalence Index = B/A = <u>3.93</u>
Sapling/Shrub Stratum (Plot size: _____)	1. _____	_____	_____	
2. _____	_____	_____	_____	
3. _____	_____	_____	_____	
4. _____	_____	_____	_____	
5. _____	_____	_____	_____	
_____ = Total Cover				
Herb Stratum (Plot size: <u>5' radius</u>)	1. <u>Lobularia maritima</u>	<u>15</u>	<u>Y</u> <u>UPL</u>	
2. <u>Distichlis spicata</u>	<u>15</u>	<u>Y</u> <u>FAC</u>		
3. <u>Bromus hordeaceus (?)</u>	<u>15</u>	<u>Y</u> <u>FACU</u>		
4. <u>Festuca perennis (?)</u>	<u>15</u>	<u>Y</u> <u>FAC</u>		
5. <u>Malva parviflora</u>	<u>5</u>	<u>N</u> <u>UPL</u>		
6. <u>Erodium cicutarium</u>	<u>5</u>	<u>N</u> <u>UPL</u>		
7. <u>Unknown grass/forb seedlings</u>	<u>30</u>	<u>N</u>		
8. _____	_____	_____	_____	
_____ = Total Cover				
Woody Vine Stratum (Plot size: _____)	1. _____	_____	_____	
2. _____	_____	_____	_____	
_____ = Total Cover				
% Bare Ground in Herb Stratum <u>0</u>	% Cover of Biotic Crust <u>0</u>			

Remarks:
 Sample point not dominated by hydrophytic vegetation, but plant ID extremely difficult due to disturbance and time of year. Abundant seedlings not identifiable, best professional judgment used. Dominance could change based on season. Distichlis appears most dominant in sandy soils, and is possibly responding to sandy substrate rather than hydrology.

SOIL

Sampling Point: 2

Profile Description: (Describe to the depth needed to document the indicator or confirm the absence of indicators.)

Depth (inches)	Matrix		Redox Features				Texture	Remarks
	Color (moist)	%	Color (moist)	%	Type ¹	Loc ²		
0-4	10YR 3/2	100					sndy loam	
4-10	10YR 4/4	100					loamy snd	
10-20	10YR 3/3	100					loamy snd	

¹Type: C=Concentration, D=Depletion, RM=Reduced Matrix, CS=Covered or Coated Sand Grains. ²Location: PL=Pore Lining, M=Matrix.

Hydric Soil Indicators: (Applicable to all LRRs, unless otherwise noted.)	Indicators for Problematic Hydric Soils ³ :
<input type="checkbox"/> Histosol (A1)	<input type="checkbox"/> 1 cm Muck (A9) (LRR C)
<input type="checkbox"/> Histic Epipedon (A2)	<input type="checkbox"/> 2 cm Muck (A10) (LRR B)
<input type="checkbox"/> Black Histic (A3)	<input type="checkbox"/> Reduced Vertic (F18)
<input type="checkbox"/> Hydrogen Sulfide (A4)	<input type="checkbox"/> Red Parent Material (TF2)
<input type="checkbox"/> Stratified Layers (A5) (LRR C)	<input type="checkbox"/> Other (Explain in Remarks)
<input type="checkbox"/> 1 cm Muck (A9) (LRR D)	
<input type="checkbox"/> Depleted Below Dark Surface (A11)	
<input type="checkbox"/> Thick Dark Surface (A12)	
<input type="checkbox"/> Sandy Mucky Mineral (S1)	
<input type="checkbox"/> Sandy Gleyed Matrix (S4)	
<input type="checkbox"/> Sandy Radox (S5)	
<input type="checkbox"/> Stripped Matrix (S6)	
<input type="checkbox"/> Loamy Mucky Mineral (F1)	
<input type="checkbox"/> Loamy Gleyed Matrix (F2)	
<input type="checkbox"/> Depleted Matrix (F3)	
<input type="checkbox"/> Redox Dark Surface (F6)	
<input type="checkbox"/> Depleted Dark Surface (F7)	
<input type="checkbox"/> Redox Depressions (F8)	
<input type="checkbox"/> Vernal Pools (F9)	

³Indicators of hydrophytic vegetation and wetland hydrology must be present, unless disturbed or problematic.

Restrictive Layer (if present):
 Type: none
 Depth (inches): _____

Hydric Soil Present? Yes _____ No

Remarks:
 Soils highly disturbed. Do not match mapped type. Restrictive layer not present, but occasional clay layer observed in surrounding soils >12 inches deep with 10YR 4/6 redox features occurring at/below this layer. Possibly impedes drainage, but redox generally not observed in upper 12 inches of soil profile.

HYDROLOGY

Wetland Hydrology Indicators:

Primary Indicators (minimum of one required; check all that apply)	Secondary Indicators (2 or more required)
<input type="checkbox"/> Surface Water (A1)	<input type="checkbox"/> Salt Crust (B11)
<input type="checkbox"/> High Water Table (A2)	<input type="checkbox"/> Biotic Crust (B12)
<input type="checkbox"/> Saturation (A3)	<input type="checkbox"/> Aquatic Invertebrates (B13)
<input type="checkbox"/> Water Marks (B1) (Nonriverine)	<input type="checkbox"/> Hydrogen Sulfide Odor (C1)
<input type="checkbox"/> Sediment Deposits (B2) (Nonriverine)	<input type="checkbox"/> Oxidized Rhizospheres along Living Roots (C3)
<input type="checkbox"/> Drift Deposits (B3) (Nonriverine)	<input type="checkbox"/> Presence of Reduced Iron (C4)
<input type="checkbox"/> Surface Soil Cracks (B6)	<input type="checkbox"/> Recent Iron Reduction in Tilled Soils (C6)
<input type="checkbox"/> Inundation Visible on Aerial Imagery (B7)	<input type="checkbox"/> Thin Muck Surface (C7)
<input type="checkbox"/> Water-Stained Leaves (B9)	<input type="checkbox"/> Other (Explain in Remarks)
	<input type="checkbox"/> Water Marks (B1) (Riverine)
	<input type="checkbox"/> Sediment Deposits (B2) (Riverine)
	<input type="checkbox"/> Drift Deposits (B3) (Riverine)
	<input type="checkbox"/> Drainage Patterns (B10)
	<input type="checkbox"/> Dry-Season Water Table (C2)
	<input type="checkbox"/> Crayfish Burrows (C8)
	<input type="checkbox"/> Saturation Visible on Aerial Imagery (C9)
	<input type="checkbox"/> Shallow Aquitard (D3)
	<input type="checkbox"/> FAC-Neutral Test (D5)

Field Observations:

Surface Water Present? Yes _____ No <input checked="" type="checkbox"/>	Depth (inches): <u>none</u>	Wetland Hydrology Present? Yes _____ No <input checked="" type="checkbox"/>
Water Table Present? Yes _____ No <input checked="" type="checkbox"/>	Depth (inches): <u>none</u>	
Saturation Present? Yes _____ No <input checked="" type="checkbox"/>	Depth (inches): <u>none</u>	

Describe Recorded Data (stream gauge, monitoring well, aerial photos, previous inspections), if available:
 None

Remarks:
 Soils dry. No wetland hydrology indicators observed.

WETLAND DETERMINATION DATA FORM – Arid West Region

Project/Site: 115 West Point Avenue City/County: El Granada/San Mateo County Sampling Date: 12/19/13
 Applicant/Owner: Reza Malek State: CA Sampling Point: 3
 Investigator(s): Coast Range Biological, LLC Section, Township, Range: T5S,R6W,sec14
 Landform (hillslope, terrace, etc.): terrace Local relief (concave, convex, none): level Slope (%): 0
 Subregion (LRR): LRR-A Lat: 37.S02143 Long: -122.493285 Datum: WGS84
 Soil Map Unit Name: Denison clay loam, nearly level NWI classification: Upland

Are climatic / hydrologic conditions on the site typical for this time of year? Yes No (If no, explain in Remarks.)
 Are Vegetation , Soil , or Hydrology significantly disturbed? Are "Normal Circumstances" present? Yes No
 Are Vegetation , Soil , or Hydrology naturally problematic? (If needed, explain any answers in Remarks.)

SUMMARY OF FINDINGS – Attach site map showing sampling point locations, transects, important features, etc.

Hydrophytic Vegetation Present? Yes <input type="checkbox"/> No <input checked="" type="checkbox"/> Hydric Soil Present? Yes <input type="checkbox"/> No <input checked="" type="checkbox"/> Wetland Hydrology Present? Yes <input type="checkbox"/> No <input checked="" type="checkbox"/>	Is the Sampled Area within a Wetland? Yes <input type="checkbox"/> No <input checked="" type="checkbox"/>
Remarks: Located in level area south of house. No wetland indicators observed.	

VEGETATION – Use scientific names of plants.

Tree Stratum (Plot size: _____)	Absolute % Cover	Dominant Species?	Indicator Status	Dominance Test worksheet:
1. _____	_____	_____	_____	Number of Dominant Species That Are OBL, FACW, or FAC: <u>0</u> (A)
2. _____	_____	_____	_____	Total Number of Dominant Species Across All Strata: <u>2</u> (B)
3. _____	_____	_____	_____	Percent of Dominant Species That Are OBL, FACW, or FAC: <u>0</u> (A/B)
4. _____	_____	_____	_____	
_____ = Total Cover				
Sapling/Shrub Stratum (Plot size: _____)				
1. _____	_____	_____	_____	Prevalence Index worksheet: Total % Cover of: _____ Multiply by: _____ OBL species _____ x 1 = _____ FACW species _____ x 2 = _____ FAC species <u>5</u> x 3 = <u>15</u> FACU species _____ x 4 = _____ UPL species <u>80</u> x 5 = <u>400</u> Column Totals: <u>85</u> (A) <u>415</u> (B) Prevalence Index = B/A = <u>4.88</u>
2. _____	_____	_____	_____	
3. _____	_____	_____	_____	
4. _____	_____	_____	_____	
5. _____	_____	_____	_____	
_____ = Total Cover				
Herb Stratum (Plot size: <u>5' radius</u>)				
1. <u>Oxalis pes-caprae</u>	<u>40</u>	<u>Y</u>	<u>UPL</u>	Hydrophytic Vegetation Indicators: ___ Dominance Test is >50% ___ Prevalence Index is ≤3.0 ¹ ___ Morphological Adaptations ¹ (Provide supporting data in Remarks or on a separate sheet) ___ Problematic Hydrophytic Vegetation ¹ (Explain) ¹ Indicators of hydric soil and wetland hydrology must be present, unless disturbed or problematic.
2. <u>Lobularia maritima</u>	<u>30</u>	<u>Y</u>	<u>UPL</u>	
3. <u>Malva parviflora</u>	<u>10</u>	<u>N</u>	<u>UPL</u>	
4. <u>Festuca perennis</u>	<u>5</u>	<u>N</u>	<u>FAC</u>	
5. <u>Unknown grass/forb seedlings</u>	<u>10</u>	<u>N</u>	_____	
6. _____	_____	_____	_____	
7. _____	_____	_____	_____	
8. _____	_____	_____	_____	
_____ = Total Cover				
Woody Vine Stratum (Plot size: _____)				
1. _____	_____	_____	_____	Hydrophytic Vegetation Present? Yes <input type="checkbox"/> No <input checked="" type="checkbox"/>
2. _____	_____	_____	_____	
_____ = Total Cover				
% Bare Ground in Herb Stratum <u>5</u>		% Cover of Biotic Crust <u>0</u>		

Remarks:
 Sample point not dominated by hydrophytic vegetation. Some species not identifiable due to season.

SOIL

Sampling Point: 3

Profile Description: (Describe to the depth needed to document the indicator or confirm the absence of indicators.)								
Depth (inches)	Matrix		Redox Features				Texture	Remarks
	Color (moist)	%	Color (moist)	%	Type ¹	Loc ²		
0-8	10YR 3/2	100					loam	
8-20	10YR 4/4	100					sndy loam	
¹ Type: C=Concentration, D=Depletion, RM=Reduced Matrix, CS=Covered or Coated Sand Grains. ² Location: PL=Pore Lining, M=Matrix.								
Hydric Soil Indicators: (Applicable to all LRRs, unless otherwise noted.)						Indicators for Problematic Hydric Soils ³ :		
<input type="checkbox"/> Histosol (A1) <input type="checkbox"/> Histic Epipedon (A2) <input type="checkbox"/> Black Histic (A3) <input type="checkbox"/> Hydrogen Sulfide (A4) <input type="checkbox"/> Stratified Layers (A5) (LRR C) <input type="checkbox"/> 1 cm Muck (A9) (LRR D) <input type="checkbox"/> Depleted Below Dark Surface (A11) <input type="checkbox"/> Thick Dark Surface (A12) <input type="checkbox"/> Sandy Mucky Mineral (S1) <input type="checkbox"/> Sandy Gleyed Matrix (S4)			<input type="checkbox"/> Sandy Redox (S5) <input type="checkbox"/> Stripped Matrix (S6) <input type="checkbox"/> Loamy Mucky Mineral (F1) <input type="checkbox"/> Loamy Gleyed Matrix (F2) <input type="checkbox"/> Depleted Matrix (F3) <input type="checkbox"/> Redox Dark Surface (F6) <input type="checkbox"/> Depleted Dark Surface (F7) <input type="checkbox"/> Redox Depressions (F8) <input type="checkbox"/> Vernal Pools (F9)			<input type="checkbox"/> 1 cm Muck (A9) (LRR C) <input type="checkbox"/> 2 cm Muck (A10) (LRR B) <input type="checkbox"/> Reduced Vertic (F18) <input type="checkbox"/> Red Parent Material (TF2) <input type="checkbox"/> Other (Explain in Remarks)		
Restrictive Layer (if present): Type: <u>none</u> Depth (inches): _____						Hydric Soil Present? Yes _____ No <input checked="" type="checkbox"/>		
Remarks: Soils do not match mapped type.								

HYDROLOGY

Wetland Hydrology Indicators:		
Primary Indicators (minimum of one required; check all that apply)	Secondary Indicators (2 or more required)	
<input type="checkbox"/> Surface Water (A1) <input type="checkbox"/> High Water Table (A2) <input type="checkbox"/> Saturation (A3) <input type="checkbox"/> Water Marks (B1) (Nonriverine) <input type="checkbox"/> Sediment Deposits (B2) (Nonriverine) <input type="checkbox"/> Drift Deposits (B3) (Nonriverine) <input type="checkbox"/> Surface Soil Cracks (B6) <input type="checkbox"/> Inundation Visible on Aerial Imagery (B7) <input type="checkbox"/> Water-Stained Leaves (B9)	<input type="checkbox"/> Salt Crust (B11) <input type="checkbox"/> Biotic Crust (B12) <input type="checkbox"/> Aquatic Invertebrates (B13) <input type="checkbox"/> Hydrogen Sulfide Odor (C1) <input type="checkbox"/> Oxidized Rhizospheres along Living Roots (C3) <input type="checkbox"/> Presence of Reduced Iron (C4) <input type="checkbox"/> Recent Iron Reduction in Tilled Soils (C6) <input type="checkbox"/> Thin Muck Surface (C7) <input type="checkbox"/> Other (Explain in Remarks)	<input type="checkbox"/> Water Marks (B1) (Riverine) <input type="checkbox"/> Sediment Deposits (B2) (Riverine) <input type="checkbox"/> Drift Deposits (B3) (Riverine) <input type="checkbox"/> Drainage Patterns (B10) <input type="checkbox"/> Dry-Season Water Table (C2) <input type="checkbox"/> Crayfish Burrows (C8) <input type="checkbox"/> Saturation Visible on Aerial Imagery (C9) <input type="checkbox"/> Shallow Aquitard (D3) <input type="checkbox"/> FAC-Neutral Test (D5)
Field Observations: Surface Water Present? Yes _____ No <input checked="" type="checkbox"/> Depth (inches): <u>none</u> Water Table Present? Yes _____ No <input checked="" type="checkbox"/> Depth (inches): <u>none</u> Saturation Present? (includes capillary fringe) Yes _____ No <input checked="" type="checkbox"/> Depth (inches): <u>none</u>		
Describe Recorded Data (stream gauge, monitoring well, aerial photos, previous inspections), if available: None		
Remarks: No wetland hydrology indicators observed.		
Wetland Hydrology Present? Yes _____ No <input checked="" type="checkbox"/>		

APPENDIX B

DELINEATION MAP OF THE STUDY AREA

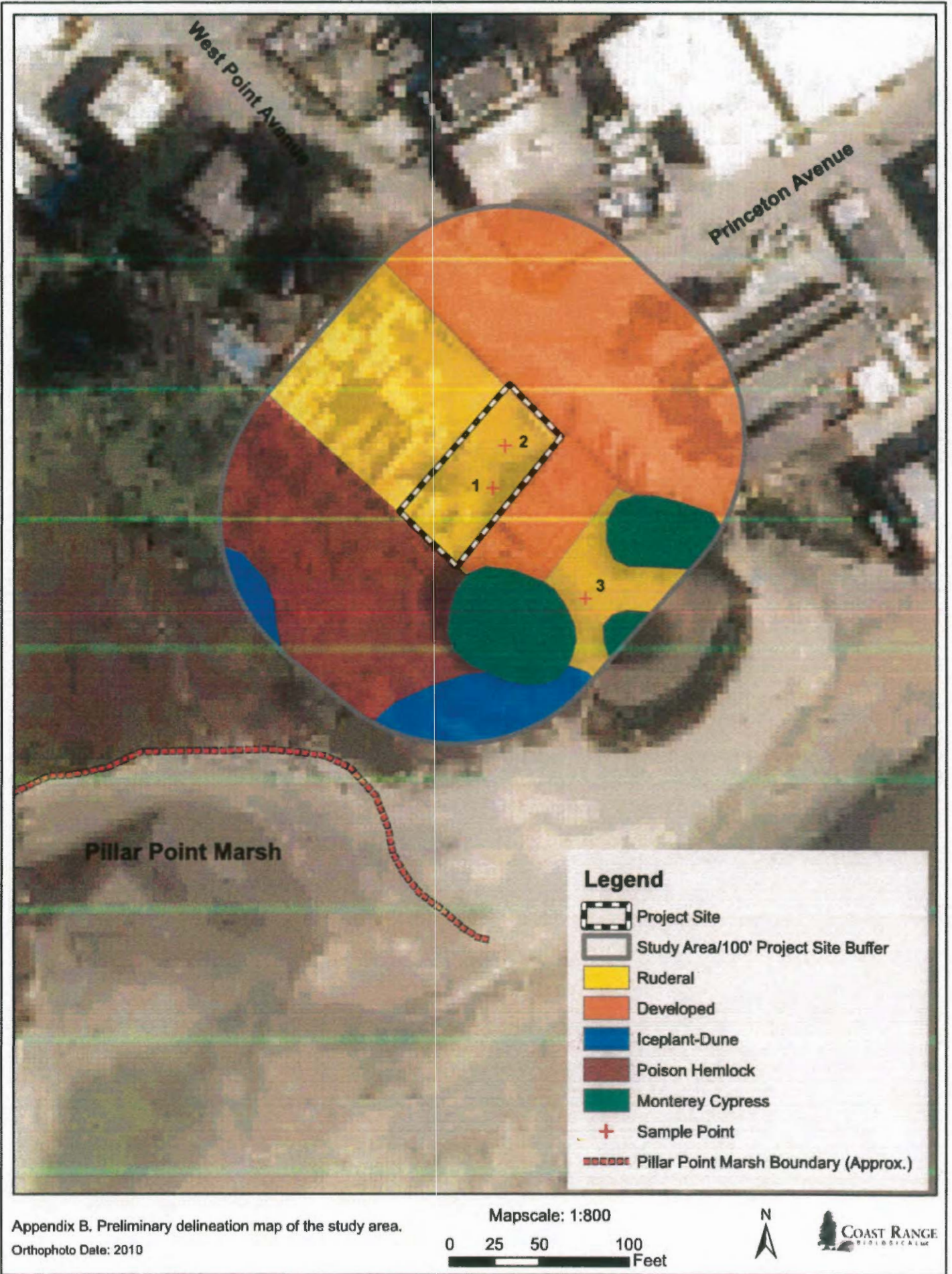

Appendix B. Preliminary delineation map of the study area.
 Orthophoto Date: 2010

APPENDIX C

STUDY AREA PHOTOS



Appendix C, Photograph 1. Project site, north of existing house, looking southwest.



Appendix C, Photograph 2. Southeast of existing house, looking northwest.

ATTACHMENT E

From the office of Jim Gillespie
CFVM, INC

Date: April 17, 2014
To: Dr. Reza Malek, care of Paravati Construction
From: Jim Gillespie, Consulting Arborist
Subject: Monterey Cypress - Review Letter

The purpose of this letter is review the current health of the Monterey cypress, *cupressus macrocarpa*, which is defined as a significant tree by San Mateo County. This tree will need to be removed to make way for the proposed remodel of the existing cottage on the property.

LOCATION OF THE TREE

The Monterey cypress is located adjacent to the southwest corner of an existing deck structure at 115 West Point Ave, in San Mateo County, California. The tree is 39 inches in diameter and is fully mature. It is important to note that the tree canopy is overtopped by another Monterey cypress within 25ft.

HEALTH OF THE TREE

The tree is in good health at the time of inspection, as there are no symptoms or signs of dangerous diseases or insects. This being said, shaded out trees may eventually succumb to insects or disease. Removing the overtopped tree will increase the amount of light and moisture received by the remaining tree and therefore increase its health, growth, and resistance to other stresses.¹

PICTURE



¹Tree Growth and Competition. 2007. 1st ed. [ebook] Oakland, California: Regents of the University of California, Division of Agriculture and Natural Resources., pp.3-5. Available at: <<http://ucanr.edu/sites/forestry/files/19051.pdf>> [Accessed 17 Apr. 2014].

RECEIVED

APR 23 2014

San Mateo County
Planning and Building Department

PLN2014 - 00133



County of San Mateo

Planning & Building Department

455 County Center, 2nd Floor
Redwood City, California 94063
650/363-4161 Fax: 650/363-4849

Mail Drop PLN122
plngbldg@smcgov.org
www.co.sanmateo.ca.us/planning

November 24, 2014

Benjamin McGriff
McGriff Architects
1475 - 15th Street
San Francisco, CA 94103

Dear Mr. McGriff:

SUBJECT: Coastside Design Review Recommended Approval
115 West Point Avenue, Princeton
APN 047-032-160; County File No. PLN 2014-00133

At its meeting of July 10, 2014, the San Mateo County Coastside Design Review Committee considered your application for design review approval as part of a Non-Conforming Use Permit, Coastal Development Permit, and Lot Merger to allow construction of a 3,973 sq. ft. two-story addition that includes a 660 sq. ft. attached two-car garage, to an existing 1,888 sq. ft. two-story single-family residence, on an existing 7,000 sq. ft. legal parcel, where 5,000 sq. ft. is the required minimum, including a proposal to remove two (2) trees. The Non-Conforming Use Permit is required, pursuant to Section 6134.6 of the County Zoning Regulations, to allow enlargement of a non-conforming residential use in a non-residential (Waterfront) Zoning District. The Lot Merger is required to accommodate the proposed expansion. The project is appealable to the California Coastal Commission.

Based on the plans, application forms and accompanying materials submitted, the Coastside Design Review Committee recommended approval of your project based on and subject to the following findings and recommended conditions of approval:

FINDINGS

The Coastside Design Review Officer found that:

1. For the Environmental Review

This project is exempt from environmental review pursuant to the California Environmental Quality Act (CEQA), Section 15301, Class 1(e), relating to additions to existing structures.

The Coastside Design Review Committee found that:

2. For the Design Review

This project is in compliance with the Design Review Standards for One-Family Residential Development in the Midcoast, Section 6565.20 of the San Mateo County Zoning Regulations, specifically elaborated as follows:

ATTACHMENT F

- a. The proposed structure exhibits numerous articulated areas that include the connection of two structures with an enclosed entry hall, and architectural features such as gables and dormers (Section 6565.20(D)1.d and e).
- b. The proposed architectural style incorporates design elements such as gable roofs, dormers and well placed fenestrations framed with trims. As proposed, the home establishes itself as an example for future neighborhood renovations (Section 6565.20(D)2).
- c. The primary gable roof form serves both as a mitigating element for mass and bulk and maintains consistency with the existing home's roof form (Section 6565.20(D)3).
- d. As proposed and conditioned, the materials such as western red cedar shingles and earth-tone colors as the project's color scheme enhance the neighborhood and are compatible with coastal architecture in the area. Condition No. 4.a includes a recommendation to explore changing the exterior material at the entry corner hall to a translucent material, if deemed feasible (Section 6565.20(D)4).

RECOMMENDED CONDITIONS OF APPROVAL

Current Planning Section

1. The project shall be constructed in compliance with the plans recommended for approval by the Coastside Design Review Committee on July 10, 2014. Any changes or revisions to the approved plans shall be submitted to the Design Review Officer, subject to review and approval, prior to implementation. Minor adjustments to the project may be approved by the Design Review Officer if they are consistent with the intent of and are in substantial conformance with this approval. Alternatively, the Design Review Officer may refer consideration of the revisions to the Coastside Design Review Committee, with applicable fees to be paid.
2. The design review final approval shall be valid for five (5) years from the date of approval, in which time a building permit shall be issued and a completed inspection (to the satisfaction of the Building Inspector) shall have occurred within 180 days of its issuance. The design review approval may be extended by one 1-year increment with submittal of an application for permit extension and payment of applicable extension fees sixty (60) days prior to the expiration date.
3. The applicant shall include the recommended approval letter on the top pages of the building plans.
4. The applicant shall submit the following items and/or indicate the following on plans submitted for a building permit, as stipulated by the Coastside Design Review Committee:
 - a. Exterior material at the entry corner hall may be of translucent material, if deemed feasible.

5. The applicant shall provide "finished floor elevation verification" to certify that the structure is actually constructed at the height shown on the submitted plans. The applicant shall have a licensed land surveyor or engineer establish a baseline elevation datum point in the vicinity of the construction site.
 - a. The applicant shall maintain the datum point so that it will not be disturbed by the proposed construction activities until final approval of the building permit.
 - b. This datum point and its elevation shall be shown on the submitted site plan. This datum point shall be used during construction to verify the elevation of the finished floors relative to the existing natural or to the grade of the site (finished grade).
 - c. Prior to Planning approval of the building permit application, the applicant shall also have the licensed land surveyor or engineer indicate on the construction plans: (1) the natural grade elevations at the significant corners (at least four) of the footprint of the proposed structure on the submitted site plan, and (2) the elevations of proposed finished grades.
 - d. In addition, (1) the natural grade elevations at the significant corners of the proposed structure, (2) the finished floor elevations, (3) the topmost elevation of the roof and (4) garage slab elevation must be shown on the plan, elevations, and cross-section (if one is provided).
 - e. Once the building is under construction, prior to the below floor framing inspection or the pouring of the concrete slab (as the case may be) for the lowest floor(s), the applicant shall provide to the Building Inspection Section a letter from the licensed land surveyor or engineer certifying that the lowest floor height--as constructed--is equal to the elevation specified for that floor in the approved plans. Similarly, certifications on the garage slab and the topmost elevation of the roof are required.
 - f. If the actual floor height, garage slab, or roof height--as constructed--is different than the elevation specified in the plans, then the applicant shall cease all construction and no additional inspections shall be approved until a revised set of plans is submitted to and subsequently approved by both the Building Official and Community Development Director.

6. During project construction, the applicant shall, pursuant to Chapter 4.100 of the San Mateo County Ordinance Code, minimize the transport and discharge of stormwater runoff from the construction site into storm drain systems and water bodies by:
 - a. Using filtration materials on storm drain covers to remove sediment from dewatering effluent.
 - b. Stabilizing all denuded areas and maintaining erosion control measures continuously between October 1 and April 30.

- c. Removing spoils promptly, and avoiding stockpiling of fill materials, when rain is forecast. If rain threatens, stockpiled soils and other materials shall be covered with a tarp or other waterproof material.
 - d. Storing, handling, and disposing of construction materials and wastes so as to avoid their entry to the storm drain system or water body.
 - e. Avoiding cleaning, fueling or maintaining vehicles on-site, except in an area designated to contain and treat runoff.
 - f. Limiting and timing application of pesticides and fertilizers to avoid polluting runoff.
7. The applicant shall include an erosion and sediment control plan on the plans submitted for the building permit. This plan shall identify the type and location of erosion control measures to be installed upon the commencement of construction in order to maintain the stability of the site and prevent erosion and sedimentation off-site.
8. All new power and telephone utility lines from the street or nearest existing utility pole to the main dwelling and/or any other structure on the property shall be placed underground.
9. The applicant shall apply for a building permit and shall adhere to all requirements from the Building Inspection Section, the Department of Public Works and the Coastside Fire Protection District.
10. No site disturbance shall occur, including any grading or tree removal, until a building permit has been issued, and then only those trees approved for removal shall be removed.
11. To reduce the impact of construction activities on neighboring properties, comply with the following:
 - a. All debris shall be contained on-site; a dumpster or trash bin shall be provided on-site during construction to prevent debris from blowing onto adjacent properties. The applicant shall monitor the site to ensure that trash is picked up and appropriately disposed of daily.
 - b. The applicant shall remove all construction equipment from the site upon completion of the use and/or need of each piece of equipment which shall include but not be limited to tractors, back hoes, cement mixers, etc.
 - c. The applicant shall ensure that no construction-related vehicles shall impede through traffic along the right-of-way on West Point Avenue. All construction vehicles shall be parked on-site outside the public right-of-way or in locations which do not impede safe access on West Point Avenue. There shall be no storage of construction vehicles in the public right-of-way.
12. The exterior color samples submitted to the Coastside Design Review Committee are approved. Color verification shall occur in the field after the applicant has applied the approved materials and colors but before a final inspection has been scheduled.

13. Noise levels produced by the proposed construction activity shall not exceed the 80-dBA level at any one moment. Construction activities shall be limited to the hours from 7:00 a.m. to 6:00 p.m., Monday through Friday, and 9:00 a.m. to 5:00 p.m. on Saturday. Construction operations shall be prohibited on Sunday and any national holiday.

Building Inspection Section

14. The applicant shall apply for a building permit.

Department of Public Works

15. Prior to the issuance of the building permit or planning permit (for Provision C3 Regulated Projects), the applicant shall have prepared, by a registered civil engineer, a drainage analysis of the proposed project and submit it to the Department of Public Works for review and approval. The drainage analysis shall consist of a written narrative and a plan. The flow of the stormwater onto, over, and off the property shall be detailed on the plan and shall include adjacent lands as appropriate to clearly depict the pattern of flow. The analysis shall detail the measures necessary to certify adequate drainage. Post-development flows and velocities shall not exceed those that existed in the pre-developed state. Recommended measures shall be designed and included in the improvement plans and submitted to the Department of Public Works for review and approval.
16. Prior to the issuance of the building permit, the applicant shall submit a driveway "Plan and Profile," to the Department of Public Works, showing the driveway access to the parcel (garage slab) complying with County Standards for driveway slopes (not to exceed 20%) and to County Standards for driveways (at the property line) being the same elevation as the center of the access roadway. When appropriate, as determined by the Department of Public Works, this plan and profile shall be prepared from elevations and alignment shown on the roadway improvement plans. The driveway plan shall also include and show specific provisions and details for both the existing and the proposed drainage patterns and drainage facilities.
17. No proposed construction work within the County right-of-way shall begin until County requirements for the issuance of an encroachment permit, including review of the plans, have been met and an encroachment permit issued. Applicant shall contact a Department of Public Works Inspector 48 hours prior to commencing work in the right-of-way.
18. The applicant shall submit to the project planner a copy of the recorded Grant Deed(s) of only the parcels to be merged for review and approval prior to Planning Department approval.
19. Prior to the issuance of the building permit, the applicant will be required to provide payment of "roadway mitigation fees" based on the square footage (assessable space) of the proposed building per Ordinance No. 3277.
20. The applicant shall submit a permanent stormwater management plan in compliance with the County's Drainage Policy and NPDES requirements for review and approval by the Department of Public Works.

Coastside Fire Protection District

21. Smoke detectors which are hardwired: As per the California Building Code, State Fire Marshal Regulations, and Coastside Fire District Ordinance No. 2013-03, the applicant is required to install State Fire Marshal approved and listed smoke detectors which are hardwired, interconnected, and have battery backup. These detectors are required to be placed in each new and recondition sleeping room and at a point centrally located in the corridor or area giving access to each separate sleeping area. In existing sleeping rooms, areas may have battery powered smoke alarms. A minimum of one detector shall be placed on each floor. Smoke detectors shall be tested and approved prior to the building final.
22. Add note: Escape or rescue windows shall have a minimum net clear openable area of 5.7 sq. ft. Five (5) sq. ft. allowed at grade. The minimum net clear openable height dimension shall be 24 inches. The net clear openable width dimension shall be 20 inches. Finished sill height shall be not more than 44 inches above the finished floor.
23. Occupancy Separation: As per the 2013 CBC, Section 406.3.4, a one-hour occupancy separation wall shall be installed with a solid core, 20-minute fire rated, self-closing door assembly with smoke gasket between the garage and the residence. All electrical boxes installed in rated walls shall be metal or protected.
24. New attached garage to meet occupancy separation requirements. Provide note/detail. CRC R302.6
25. Address Numbers: As per Coastside Fire District Ordinance No. 2013-03, building identification shall be conspicuously posted and visible from the street. (TEMPORARY ADDRESS NUMBERS SHALL BE POSTED PRIOR TO COMBUSTIBLES BEING PLACED ON-SITE.) The letters/numerals for permanent address signs shall be 4 inches in height with a minimum 3/4-inch stroke. Such letters/numerals shall be internally illuminated and facing the direction of access. Finished height of bottom of address light unit shall be greater than or equal to 6 feet from finished grade. When the building is served by a long driveway or is otherwise obscured, a 6-inch by 18-inch green reflective metal sign with 3-inch reflective numbers/letters similar to Hy-Ko 911 or equivalent shall be placed at the entrance from the nearest public roadway. See Fire Ordinance for standard sign.
26. Roof Covering: As per Coastside Fire District Ordinance No. 2013-03, the roof covering of every new building or structure, and materials applied as part of a roof covering assembly, shall have a minimum fire rating of Class "B" or higher as defined in the current edition of the California Building Code.
27. Vegetation management: As per the Coastside Fire District Ordinance No. 2013-03, the 2013 California Fire Code (CFC) and Public Resources Code 4291, a fuelbreak of defensible space is required around the perimeter of all structures to a distance of not less than 30 feet and may be required to a distance of 100 feet or to the property line. In SRA (State Responsible Area), the fuelbreak is 100 feet or to the property line.

28. Trees located within the defensible space shall be pruned to remove dead and dying portions, and limbed up 6 to 10 feet above the ground. New trees planted in the defensible space shall be located no closer than 10 feet to adjacent trees when fully grown or at maturity.
29. Remove that portion of any existing tree, which extends within 10 feet of the outlet of a chimney or stovepipe or is within 5 feet of any structure.
30. Fire Access Roads: The applicant must have a maintained all-weather surface road for ingress and egress of fire apparatus. The San Mateo County Department of Public Works, the Coastside Fire District Ordinance No. 2013-03, and the California Fire Code shall set road standards. As per the 2013 CFC, dead-end roads exceeding 150 feet shall be provided with a turnaround in accordance with Half Moon Bay Fire District specifications. As per the 2007 CFC, Section Appendix D, road width shall not be less than 20 feet. Fire access roads shall be installed and made serviceable prior to combustibles being placed on the project site and maintained during construction. Approved signs and painted curbs or lines shall be provided and maintained to identify fire access roads and state the prohibition of their obstruction. If the road width does not allow parking on the street (20-foot road) and on-street parking is desired, an additional improved area shall be developed for that use.
31. Fire Hydrant: As per 2013 CFC, Appendix B and C, a fire district approved fire hydrant (Clow 960) must be located within 250 feet of the proposed single-family dwelling unit measured by way of drivable access. As per 2013 CFC, Appendix B, the hydrant must produce a minimum fire flow of 1,000 gallons per minute at 20 pounds per square inch residual pressure for 2 hours. Contact the local water purveyor or water flow details.
32. Show the location of fire hydrant on a site plan. A fire hydrant is required within 250 feet of the building and flow a minimum of gallons per minute at 20 pounds per square inch. This information is to be verified by the water purveyor in a letter initiated by the applicant and sent to San Mateo County Fire/Cal-Fire or Coastside Fire District. If there is not a hydrant within 250 feet with the required flow, one will have to be installed at the applicant's expense.
33. Automatic Fire Sprinkler System: As per San Mateo County Building Standards and Coastside Fire District Ordinance No. 2103-03, the applicant is required to install an automatic fire sprinkler system throughout the proposed improved dwelling and garage. All attic access locations will be provided with a pilot head on a metal upright. All areas that are accessible for storage purposes shall be equipped with fire sprinklers including closets and bathrooms. The only exception is small linen closets less than 24 sq. ft. with full depth shelving. The plans for this system must be submitted to the San Mateo County Planning and Building Department or the City of Half Moon Bay. A building permit will not be issued until plans are received, reviewed and approved. Upon submission of plans, the County or City will forward a complete set to the Coastside Fire District for review. The fee schedule for automatic fire sprinkler systems shall be in accordance with Half Moon Bay Ordinance No. 2006-01. Fees shall be paid prior to plan review if addition/remodel exceeds 50% valuation.

34. All fire conditions and requirements must be incorporated into your building plans prior to building permit issuance. It is your responsibility to notify your contractor, architect and engineer of these requirements.

Coastside County Water District

35. Prior to the issuance of a building permit, the applicant shall obtain a water service connection to include a backflow device.

Geotechnical Section

36. The applicant shall submit a new or updated geotechnical report at the building application stage.

Please note that the decision of the Coastside Design Review Committee is a recommendation regarding the project's compliance with Design Review Standards, not the final decision on this project, which requires a Non-Conforming Use Permit, Coastal Development Permit, and Lot Merger. The decision on the Non-Conforming Use Permit, Coastal Development Permit, and Lot Merger will take place at a later date. For more information, please contact the project planner, Dennis P. Aguirre, at 650/363-1867, or by email at daguirre@smcgov.org.

Sincerely,



Dennis P. Aguirre
Design Review Officer

DPA:pac – DPAY1065_WPN.DOCX

Attachment

cc: Diane Whitaker, Architect
Willard Williams, Architect
Annette Merriman, Community Representative (Alternate)



San Mateo County Planning Commission Meeting

Owner/Applicant: Reza/McGriff

Attachment: F

File Numbers: PLN2014-00133



San Mateo County Planning Commission Meeting

Owner/Applicant: Reza/McGriff

Attachment: F

File Numbers: PLN2014-00133



San Mateo County Planning Commission Meeting

Owner/Applicant: Reza/McGriff

File Numbers: PLN2014-00133

Attachment: F



San Mateo County Planning Commission Meeting

Owner/Applicant: Reza/McGriff

Attachment: F

File Numbers: PLN2014-00133



San Mateo County Planning Commission Meeting

Owner/Applicant: Reza/McGriff

File Numbers: PLN2014-00133

Attachment: F